



ImageWriter™ II Owner's Manual



Apple® II, II Plus, IIc, IIe, III, Macintosh™, Macintosh XL/Lisa®

Copyright

©Copyright 1985, Apple Computer, Inc. for all nontextual material, graphics, figures, photographs, and all computer program listings or code in any form, including object and source code. All rights reserved.

For some products, a multi-use license may be purchased to allow the software to be used on more than one computer owned by the purchaser, including a shared-disk system. (Contact your authorized Apple dealer for information on multi-use licenses.)

Apple, the Apple logo, AppleWorks, ImageWriter II, Lisa, MacWorks, and Super Serial Card are trademarks of Apple Computer, Inc.

AppleCare is a registered service mark of Apple Computer, Inc.

Macintosh is a trademark of McIntosh Laboratory, Inc. and is being used with express permission of its owner.

Printed in Japan.

Limited Warranty on Media and Replacement

If you discover physical defects in the manuals distributed with an Apple product or in the media on which a software product is distributed, Apple will replace the media or manuals at no charge to you, provided you return the item to be replaced with proof of purchase to Apple or an authorized Apple dealer during the 90-day period after you purchased the software. In addition, Apple will replace damaged software media and manuals for as long as the software product is included in Apple's Media Exchange Program. While not an upgrade or update method, this program offers additional protection for up to two years or more from the date of your original purchase. See your authorized Apple dealer for program coverage and details. In some countries the replacement period may be different; check with your authorized Apple dealer.

ALL IMPLIED WARRANTIES ON THE MEDIA AND MANUALS, INCLUDING IMPLIED WARRANTIES OF MERCHANTABILITY AND FITNESS FOR A PARTICULAR PURPOSE, ARE LIMITED IN DURATION TO NINETY (90) DAYS FROM THE DATE OF THE ORIGINAL RETAIL PURCHASE OF THIS PRODUCT.

Even though Apple has tested the software and reviewed the documentation, **APPLE MAKES NO WARRANTY OR REPRESENTATION, EITHER EXPRESS OR IMPLIED, WITH RESPECT TO SOFTWARE, ITS QUALITY, PERFORMANCE, MERCHANTABILITY, OR FITNESS FOR A PARTICULAR PURPOSE. AS A RESULT, THIS SOFTWARE IS SOLD "AS IS," AND YOU THE PURCHASER ARE ASSUMING THE ENTIRE RISK AS TO ITS QUALITY AND PERFORMANCE.**

IN NO EVENT WILL APPLE BE LIABLE FOR DIRECT, INDIRECT, SPECIAL, INCIDENTAL, OR CONSEQUENTIAL DAMAGES RESULTING FROM ANY DEFECT IN THE SOFTWARE OR ITS DOCUMENTATION, even if advised of the possibility of such damages. In particular, Apple shall have no liability for any programs or data stored in or used with Apple products, including the costs of recovering such programs or data.

THE WARRANTY AND REMEDIES SET FORTH ABOVE ARE EXCLUSIVE AND IN LIEU OF ALL OTHERS, ORAL OR WRITTEN, EXPRESS OR IMPLIED. No Apple dealer, agent, or employee is authorized to make any modification, extension, or addition to this warranty.

Some states do not allow the exclusion or limitation of implied warranties or liability for incidental or consequential damages, so the above limitation or exclusion may not apply to you. This warranty gives you specific legal rights, and you may also have other rights which vary from state to state.

Warning

This equipment has been certified to comply with the limits for a Class B computing device, pursuant to Subpart J of Part 15 of FCC Rules. See instructions if interference to radio or television reception is suspected.



ImageWriter™ II Owner's Manual

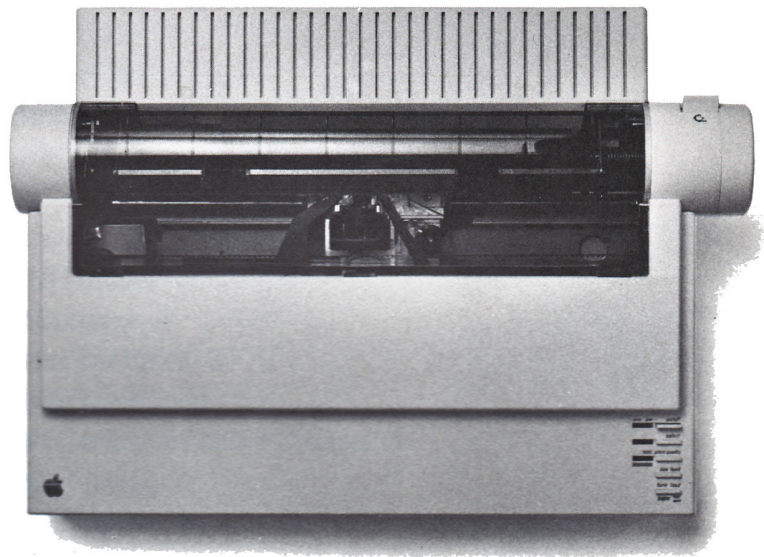

Contents

Figures and Tables	ix
Radio and Television Interference	xiii

PREFACE

About This Manual	xv
Manual Overview	xv
Aids to Understanding	xvi

CHAPTER 1

Meet the ImageWriter II	1
ImageWriter II Features	2
Features for Everyone	3
Print Quality and Speed	3
Letters, Labels, and Forms	3
Easy Paper Loading and Ribbon Changes	3
Seven-Color Printing	4
Programmable Features	4
Text Formatting and Character Sets	4
Special Formatting Features	4
ImageWriter II Accessories	5
The ImageWriter II SheetFeeder	5
The ImageWriter II 32K Memory Option	6
The ImageWriter II AppleTalk Option	6

CHAPTER 2

Basic ImageWriter II Setup

7

- Unpacking the ImageWriter II 8
- Installing the Ribbon Cartridge 10
- Starting the ImageWriter II 12
- Loading Paper 14
 - Loading Pin-Feed Paper 15
 - Loading Single Sheets of Paper 20
- Running the ImageWriter II Self-Test 23
- What's Next 24

CHAPTER 3

Connecting to Your Apple Computer

25

- Before You Begin 26
- Connecting the Printer Cable to the ImageWriter II 28
- Connecting to the Macintosh Plus and Macintosh 29
 - Solving Printer Software Problems 30
 - Macintosh Plus Software 30
 - Macintosh 128K and Macintosh 512K Software 31
- Connecting to the Apple IIc 31
- Connecting to the Apple II, II Plus, or IIe 32
 - Configuring the Apple Super Serial Card 33
 - Installing and Connecting the Serial Interface Card 34
 - Testing the Connection 37

Creating an Efficient Working Environment	40
Control Panel Details	41
The Power Light	41
The Error Light	41
The Select Button and Light	42
Selecting Print Quality	42
The Line Feed Button	43
The Form Feed/Paper Load/Eject Button	44
Pin-Feed Paper and Top of Form	44
Removing the Last Pin-Feed Page	45
Preset Top of Form	46
Eject the Last Page	47
Leave the Last Page in the Printer	47
Printing in Color	47
Loading Forms, Labels, and Envelopes	48
Adjusting for Paper Thickness	48
Finding the Correct Forms Tractor Setting	49
Loading Envelopes	50
ImageWriter II Accessories	51
The ImageWriter II SheetFeeder	51
The ImageWriter II 32K Memory Option	51
The ImageWriter II AppleTalk Option	52

CHAPTER 5

General Troubleshooting

53

You Turn the Printer On and Nothing Happens 54

The Printer Is On, But Nothing Happens 55

Error Light Problems 56

You Get a Printout, But Nothing Like You Expected 56

 Missing, Jumbled, or Random Characters 57

 Mismatched Data Transmission Rates 57

 Mismatched Data Bytes 58

 Intermittently Dropped or Random Characters 58

 Spacing Problems 58

Paper and Print Quality Problems 59

 Color Ribbon Problems 60

The ImageWriter II Self-Test 61

CHAPTER 6

ImageWriter II Care and Maintenance

63

Operating Environment 64

Cleaning the Case 64

Cleaning the Inside of Your ImageWriter II 65

Service 65

Technical Support 66

AppleCare 66

APPENDIX A

Controlling Printer Output	67
Standard Settings for the ImageWriter II	69
Changing Settings With DIP Switches	70
Using Control Characters and Escape Sequences	72
Commonly Used Printer Instructions	73
Selecting Color	76
Setting Left Margin	76
Pushing a Page to Top of Form	76
A Sample BASIC Program	77

APPENDIX B

ASCII Codes	79
--------------------	-----------

APPENDIX C

ImageWriter II Printer and Interface Specifications	83
--	-----------

APPENDIX D

Connecting to Other Apple Computers	91
Connecting the Printer Cable to the ImageWriter II	93
Connecting to the Macintosh XL	94
Solving Printer Software Problems	96
Connecting to the Lisa Office System	97
Testing the Connection	98
Connecting to the Apple III	98
Configuring the Apple III	99

APPENDIX E	<hr/> Configuring Serial Interface Cards	101
	Configuring the Apple Serial Communications Card	102
	Configuring Other Serial Cards	102
	Apple II Serial Card Notes	103
APPENDIX F	<hr/> Configuring AppleWorks for Half-Height Subscripts and Superscripts	105
	<hr/> Glossary	113
	Index	119
	Quick Reference Card	
	Tell Apple Card	

Figures and Tables

CHAPTER 1

Meet the ImageWriter II

1

- Figure 1-1 The ImageWriter II 2
Figure 1-2 The ImageWriter II SheetFeeder 5

CHAPTER 2

Basic ImageWriter II Setup

7

- Figure 2-1 Black Ribbon and Power Cord 8
Figure 2-2 Removing the Front Cover 9
Figure 2-3 Removing the Cardboard Retainer 9
Figure 2-4 Tightening the Ribbon 10
Figure 2-5 Ribbon Cartridge Deck 11
Figure 2-6 Positioning the Ribbon 11
Figure 2-7 Properly Seated Ribbon 12
Figure 2-8 ImageWriter II Power Socket 13
Figure 2-9 The On/Off Button and Related Lights 13
Figure 2-10 Removing the Back Cover 15
Figure 2-11 Opening a Paper Clamp 16
Figure 2-12 Releasing a Tractor 16
Figure 2-13 Loading Pin-Feed Paper 17
Figure 2-14 The Pin-Feed Alignment Icon 17
Figure 2-15 Pin-Feed Paper on the Forms Tractor 18
Figure 2-16 Paper Release Lever 19
Figure 2-17 Paper Loaded Under the Paper Bail 19
Figure 2-18 Paper Release Lever Set for Friction Feed 20
Figure 2-19 Aligning a Single Sheet of Paper 21
Figure 2-20 The Select and Form Feed Buttons 22
Figure 2-21 The Print Line 22

CHAPTER 3

Connecting to Your Apple Computer

25

- Figure 3-1 Apple Serial Interface Cables 27
- Figure 3-2 The 8-Pin, Mini-Circular Connector 28
- Figure 3-3 Plugging the Printer Cable Into the Printer 28
- Figure 3-4 Connecting the Printer Cable to the Macintosh Printer Port 29

- Figure 3-5 Plugging the Printer Cable Into the Apple IIc 31
- Figure 3-6 The Apple Super Serial Card 33
- Table 3-1 Super Serial Card Switch Settings 33
- Figure 3-7 Sliding the Nut Plate Onto the Ribbon Cable 34
- Figure 3-8 Positioning the Connector and the Nut Plate 35
- Figure 3-9 Attaching the Connector to the Back Panel 35
- Figure 3-10 Connecting the Ribbon Cable to the Card 36
- Figure 3-11 Installing the Super Serial Card in Slot 1 36

CHAPTER 4

Working With the ImageWriter II

39

- Figure 4-1 The ImageWriter II Control Panel 41
- Figure 4-2 Print Quality Selection Lights 43
- Figure 4-3 Tearing Off a Page 46
- Figure 4-4 The Paper Thickness Lever 48
- Figure 4-5 Setting the Paper Bail for Envelopes 50

CHAPTER 5

General Troubleshooting

53

- Figure 5-1 Ribbon Adjustment Assembly 60

APPENDIX A

Controlling Printer Output

67

Figure A-1	Location of DIP Switches	70
Table A-1	Default Settings for SW1	71
Table A-2	Default Settings for SW2	71
Table A-3	Turning Special Features On and Off	74
Table A-4	Selecting Special Features	74
Table A-5	Selecting Language Fonts	75
Table A-6	Alternate Language Fonts	75
Figure A-2	Listing for Applesoft Printer Control Program	77

APPENDIX B

ASCII Codes

79

Table B-1	ASCII Codes for Normal Characters	80
Table B-2	ASCII Codes for Inverse Characters	81

APPENDIX C

ImageWriter II Printer and Interface Specifications

83

Table C-1	Printer Specifications	84
Table C-2	ImageWriter II DIP Switch Settings	86
Table C-3	Interface Specifications	87
Table C-4	Pin Connections	88
Figure C-1	8-Pin Mini-Circular Connector Pinouts	88
Table C-5	Cable Connections	89

APPENDIX D

Connecting to Other Apple Computers 91

Figure D-1	Apple IIe Modem-8 Cable	92
Figure D-2	The 8-Pin Mini-Circular Connector	93
Figure D-3	Plugging the Printer Cable Into the Printer	94
Figure D-4	Plugging the Printer Cable Into the Serial B Port	95
Figure D-5	Connecting to Serial B Port	97
Figure D-6	Connecting to Port C	98
Table D-1	Printer Driver Configuration Block Settings	99

APPENDIX F

Configuring AppleWorks for Half-Height Subscripts and Superscripts 105

Figure F-1	Add a Printer Display	106
Figure F-2	The Printer Codes Menu	108
Figure F-3	The Enhancements Menu	109
Figure F-4	The Subscript Begin Menu	110

Radio and Television Interference

The equipment described in this manual generates and uses radio-frequency energy. If it is not installed and used properly—that is, in strict accordance with our instructions—it may cause interference with radio and television reception.

This equipment has been tested and complies with the limits for a Class B computing device in accordance with the specifications in Subpart J, Part 15, of FCC rules. These rules are designed to provide reasonable protection against such interference in a residential installation. However, there is no guarantee that the interference will not occur in a particular installation, especially if a “rabbit ear” television antenna is used. (A “rabbit ear” antenna is the telescoping-rod type usually contained on television receivers.)

You can determine whether your computer is causing interference by turning it off. If the interference stops, it was probably caused by the computer or its peripherals. To further isolate the problem, disconnect the peripheral devices and their input/output cables one at a time. If the interference stops, it was caused by either the peripheral device or the I/O cable. These devices usually require shielded I/O cables. For Apple peripherals, you can obtain the proper **shielded cable** from your dealer. For non-Apple peripheral devices, contact the manufacturer or dealer for assistance.

A **shielded cable** is a cable that uses a metallic wrap around the wires to reduce the potential effects of radio frequency interference.

If your computer does cause interference to radio or television reception, you can try to correct the interference by using one or more of the following measures:

- Turn the television or radio antenna until the interference stops.
- Move the computer to one side or the other of the television or radio.
- Move the computer farther away from the television or radio.
- Plug the computer into an outlet that is on a different circuit than the television or radio. (That is, make certain the computer and the radio or television set are on circuits controlled by different circuit breakers or fuses.)
- Consider installing a rooftop television antenna with coaxial cable lead-in between the antenna and television.

If necessary, you should consult your Apple-authorized dealer or an experienced radio/television technician for additional suggestions.

This manual helps make the setup and day-to-day operation of your ImageWriter™ II with your Apple® computer both quick and easy, even if you've never worked with a printer before. The manual takes you step-by-step through each procedure. Plenty of photographs and illustrations show important parts of the ImageWriter II and its operating procedures.

You'll also find plenty of practical tips and advice to help you get the most out of your new ImageWriter II. Before you get started, read the "Manual Overview" and the "Aids to Understanding" sections.

Manual Overview

Here's a quick overview of the manual's six chapters and six appendixes.

- Chapter 1 introduces you to the ImageWriter II's features and accessories.
- Chapter 2 shows you how to set up, start, and test the ImageWriter II.
- Chapter 3 gives instructions on connecting the ImageWriter II to the Macintosh Plus™ (including Macintosh Plus upgrades), Macintosh™, the Apple IIc, the Apple IIe, the Apple II Plus, and the Apple II.
- Chapter 4 helps you make the most of your ImageWriter II, from changing print quality to printing on address labels.
- Chapter 5 covers troubleshooting.
- Chapter 6 focuses on care and maintenance.
- Appendix A is intended for advanced users interested in controlling printer output.
- Appendix B contains ASCII code tables.
- Appendix C discusses ImageWriter II printer and interface specifications.
- Appendix D shows you how to connect your ImageWriter II to the Macintosh XL, Lisa® Office System, and Apple III computers.

- Appendix E contains configuration information for the Apple Serial Interface Card, Apple Serial Communications Card, and non-Apple cards.
- Appendix F shows you how to prepare an AppleWorks™ “custom printer.”
- A glossary of printer terms, an index, and a quick reference card conclude this manual.

For a detailed discussion of the ImageWriter II, see the *ImageWriter II Technical Reference Manual*.

Take a few minutes to fill out the Tell Apple card at the back of the manual. Let us know what you liked about the manual, and what you'd like us to do differently.

Aids to Understanding

Look for these visual cues throughout the manual:

| *By the Way:* Text set off in this manner presents sidelights or interesting pieces of information.

Important!

| Text set off in this manner—and with a tag in the margin—presents important information.

▲Warning

| Warnings like this indicate potential problems or disasters.

Computer words and phrases appear in boldface type when they are introduced. Sometimes additional information about the term may appear in the margin; the term is always defined in the glossary.

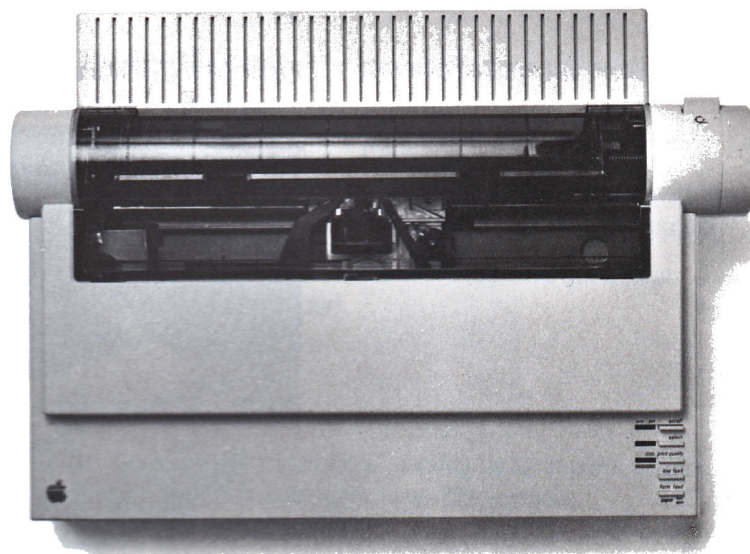

ImageWriter II Features

The Apple ImageWriter II is the ideal addition to your Apple computer. The versatile ImageWriter II combines ease of operation with a host of high-performance features to produce professional-quality graphics and text printouts.

You can expand the ImageWriter II's capabilities by choosing among three optional accessories—the ImageWriter II SheetFeeder, ImageWriter II 32K Memory Option, and ImageWriter II AppleTalk Option.

Figure 1-1. The ImageWriter II

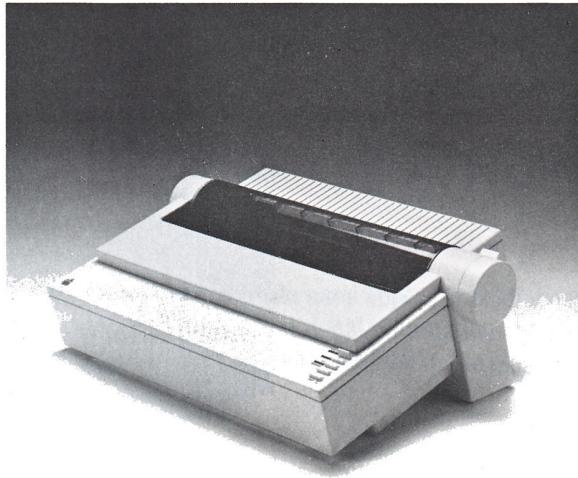

Features for Everyone

Do you want presentation quality text for an important report? Do you need to print hundreds of mailing labels? Could you show sales increases more dramatically with a bar chart in your report? Is it time to get that novel off to your publisher? The flexible ImageWriter II easily does all this and more. Consider these features for your day-to-day work.

Print Quality and Speed

You can select from among three levels of print quality at the press of a button:

- Near Letter Quality (NLQ) for formal communications and presentations
- Standard Quality for everyday work
- Draft Quality when you want a quick printout for review or editing

The ImageWriter II can print high-resolution graphics, ideal for use with the Macintosh and with graphics programs written for the Apple II computers.

The ImageWriter II's high-speed print mechanism can turn out text at speeds up to 250 characters per second.

Letters, Labels, and Forms

The ImageWriter II can handle a variety of printing tasks: reports, letters, envelopes, mailing labels, even multi-part forms like invoices.

Easy Paper Loading and Ribbon Changes

With the automatic paper loading feature, you can load single-sheet paper with the push of a button. Thanks to the built-in **forms tractor**, the ImageWriter II makes loading computer paper easier than ever before.

Likewise, ribbon changes are a snap. Ribbon cartridges click in and out quickly and neatly. Whether you print in black or color, you get high-quality images and long life from these continuous-loop, fabric ribbons.

Seven-Color Printing

To print color graphics, click in an ImageWriter II color ribbon. With color software, you can print documents in six colors plus black. You can even mix black text with color graphics.

Programmable Features

To make more sophisticated demands on the ImageWriter II, consider these programmable features.

Text Formatting and Character Sets

Using software, you can cause the ImageWriter II to print

- Boldface type
- Underlining
- Subscripts and superscripts
- Half-height characters
- Various type sizes (from 4.5 to 17 characters per inch)
- Several character sets (American plus seven European sets)
- Custom characters

Special Formatting Features

The ImageWriter II provides special formatting features:

- Horizontal tab settings
- Spacing—proportional or standard
- Lines per inch
- Lines per page

ImageWriter II Accessories

The 32K Memory Option does not benefit Macintosh nor Macintosh Plus computers.

You can further enhance your printer's performance with ImageWriter II accessories—the ImageWriter II SheetFeeder, the ImageWriter II 32K Memory Option, and the ImageWriter II AppleTalk Option.

The ImageWriter II SheetFeeder

You'll find the ImageWriter II SheetFeeder perfect for large printing jobs on individual sheets of letterhead and other standard paper. You no longer have to feed pages in one at a time. Load the SheetFeeder with up to 100 individual pages. It feeds each sheet as the printer demands, and stacks each printout.

Figure 1-2. The ImageWriter II SheetFeeder

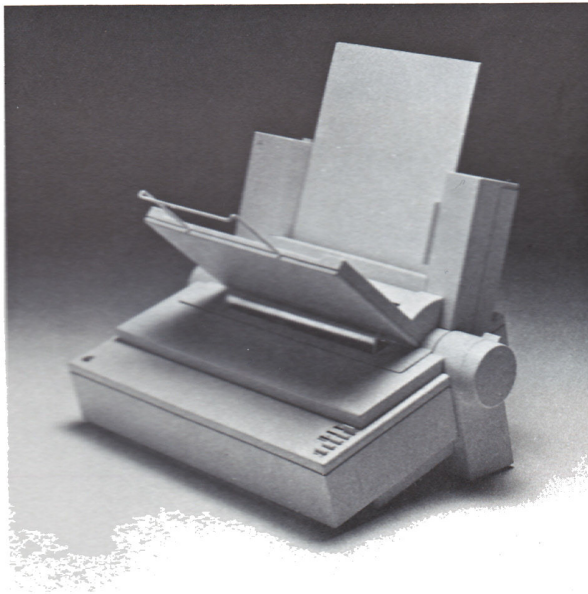

The ImageWriter II 32K Memory Option

Designed for the Apple II computers, the Memory Option is an excellent way to expand the printer's memory and increase your own productivity. With the ImageWriter II 32K Memory Option, you can send a document of up to 32,000 characters (16 to 20 pages) to the printer and continue working at the computer, while the ImageWriter II does the printing.

The ImageWriter II AppleTalk Option

The AppleTalk Option promotes shared resources in offices and schools. With the card installed, one ImageWriter II can serve as many as 31 computers on an AppleTalk network.

| *Note:* The ImageWriter II will take either the AppleTalk Option or the
| Memory Option, but not both.

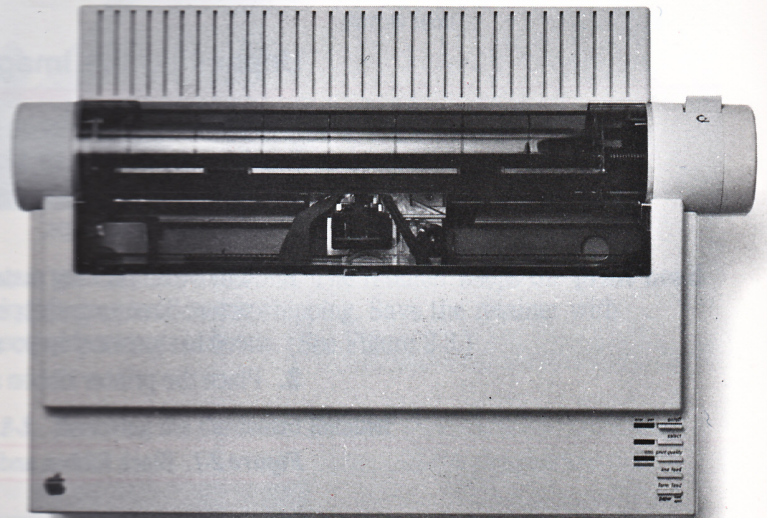

This chapter shows you how to

- unpack your ImageWriter II
- plug in the power cord
- install the ribbon
- load paper
- run the ImageWriter II's self-test.

Once you have set up your ImageWriter II, you're ready to **connect** it to your Apple computer. (If you have an ImageWriter II SheetFeeder, you might want to connect it, too.)

Unpacking the ImageWriter II

If you haven't already done so, remove the ImageWriter II from its carton. Reach *under* the printer with both hands and lift upward. For the moment, put the printer in a work area where you can easily get to its back side. Then follow these steps.

1. Remove all packing materials from the printer and return them to the carton. Save your shipping carton and packing materials, in case you need to store or ship your printer.
2. Place the printer ribbon and **power cord** beside the printer.

Figure 2-1. Black Ribbon and Power Cord

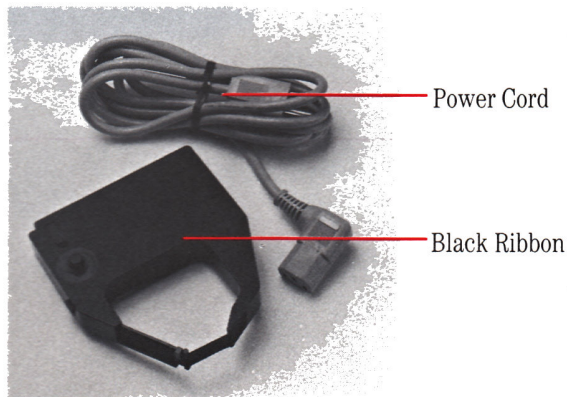

3. Remove all pieces of tape from the printer.
4. Take off the **front cover** by grasping its sides (at the arrow **icons**) and lifting upward. (See Figure 2-2.)

Figure 2-2. Removing the Front Cover

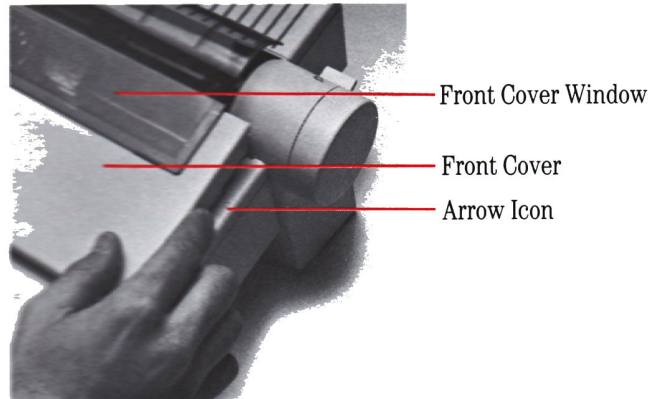

5. Remove the cardboard retainer. The retainer keeps the **print head** from sliding around during shipping. Save the retainer with **your other packing materials**. (See Figure 2-3.)

Figure 2-3. Removing the Cardboard Retainer



Looking for Power Sources: When considering where to put your Apple system, keep in mind that the ImageWriter II requires its own power source. Depending on which Apple system you have, you may need three or more electrical outlets nearby—one each for the computer, monitor, and printer. Many people prefer to plug their computer equipment into a special power strip, equipped with protection against surges in electrical current. See your authorized Apple dealer for information about power strips.

▲Warning

Electrical equipment may be hazardous if misused. Operation of this product, or similar products, must always be supervised by an adult. Do not allow children access to the interior of any electrical product and do not permit them to handle any cables.

Installing the Ribbon Cartridge

The black ribbon (provided with your ImageWriter II) and the color ribbon (purchased separately) are both continuous-loop, fabric ribbons. They will not run out, only wear out after a lot of use. Change the ribbon when characters look faded.

Installing the ribbon cartridge is simple. Here's how to do it.

1. Locate the ribbon knob on the ribbon cartridge and turn the knob clockwise to tighten the ribbon.

Figure 2-4. Tightening the Ribbon

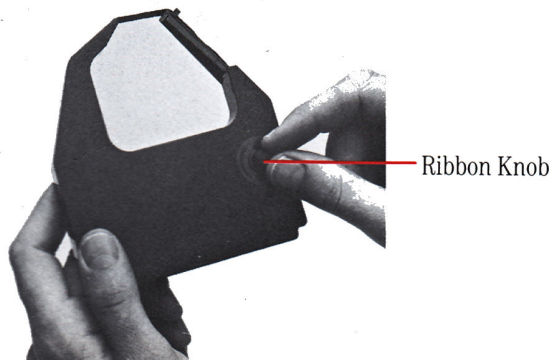

2. If the **ribbon cartridge deck** is off to the side, gently slide it toward the center to give yourself some working room.

Figure 2-5. Ribbon Cartridge Deck

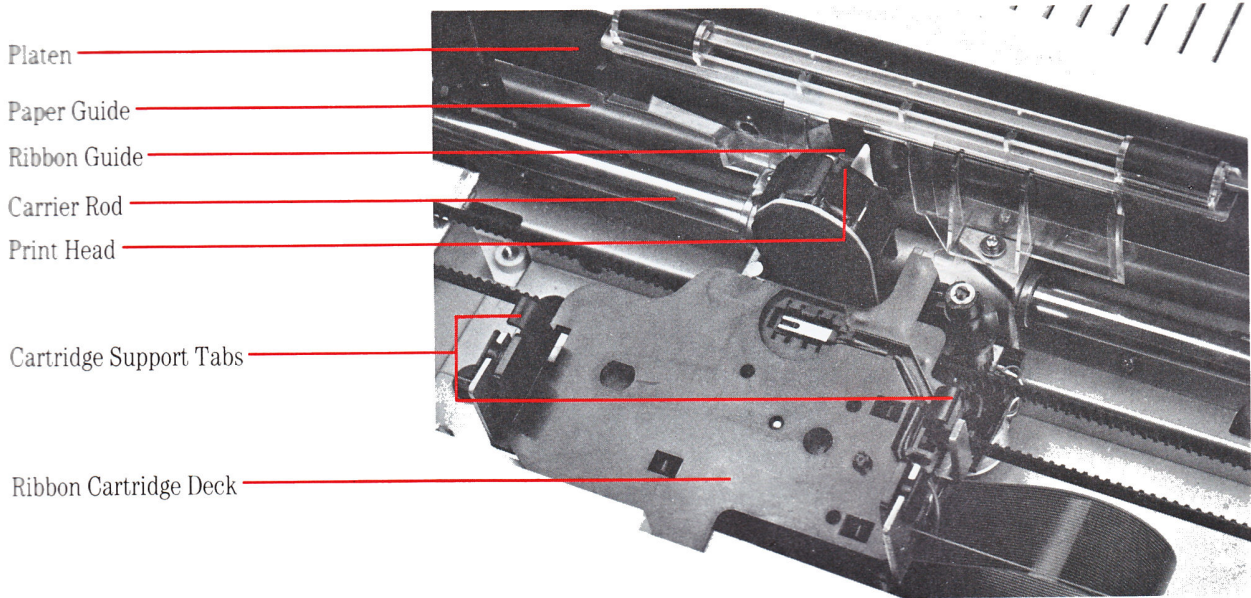

3. Lower the ribbon cartridge onto the deck. Make sure that the ribbon slips between the plastic **ribbon guide** and the clear **paper guide**.

Figure 2-6. Positioning the Ribbon

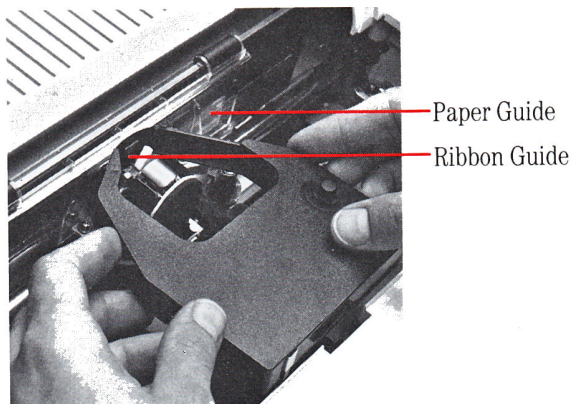

4. When the ribbon is in position, gently press the cartridge between the two **cartridge support tabs**, so that the ribbon snaps into place. Make sure the ribbon is still positioned between the ribbon and paper guides. (See Figure 2-7.)

Figure 2-7. Properly Seated Ribbon

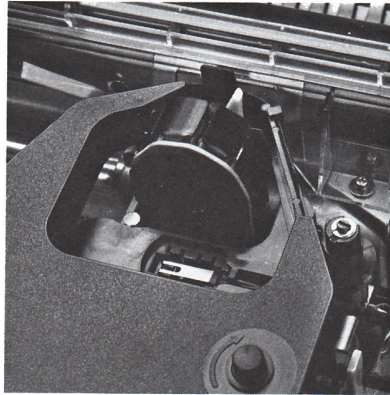

5. Take any slack out of the ribbon by turning the ribbon knob clockwise.
6. Return the front cover to the printer by slipping the cover tabs into the receiving slots and pressing down on the cover.

Removing the Ribbon Cartridge: To remove a ribbon for replacement, gently spread the support tabs and lift the cartridge out.

Important!

The printer will not function if the front cover is off or incorrectly mounted. However, you can run the printer when the **front cover window** is tilted open or removed.

Starting the ImageWriter II

Starting the printer takes two steps—plugging in the power cord and turning on the power.

1. Plug the power cord into the ImageWriter II's **power socket** and plug the three-pronged end into the power outlet. (See Figure 2-8.)

▲Warning

This equipment is intended to be electrically grounded.

Your ImageWriter II is equipped with a three-wire grounding plug—a plug having a third (grounding) pin. This plug will fit only a grounding-type AC outlet. This is a safety feature. If you are unable to insert the plug into the outlet, contact a licensed electrician to replace the outlet with a properly grounded outlet.

Do not defeat the purpose of the grounding plug!

Figure 2-8. ImageWriter II Power Socket

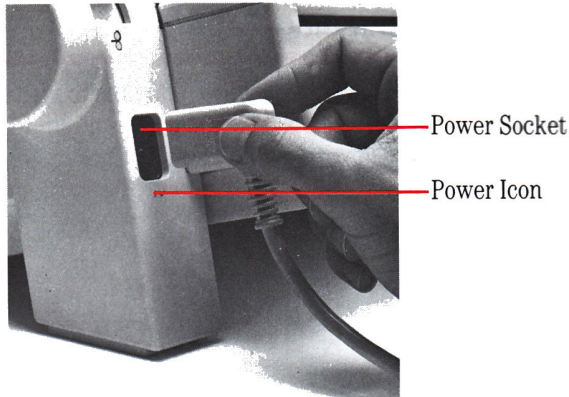

2. Press the **On/Off button**. (See Figure 2-9.) The green **Power light** and red **Error light** should light up. (The Error light is on because the printer is out of paper.) The print head moves to the left margin and then to the center. The ImageWriter II moves the print head to the center when no paper is present.

Figure 2-9. The On/Off Button and Related Lights

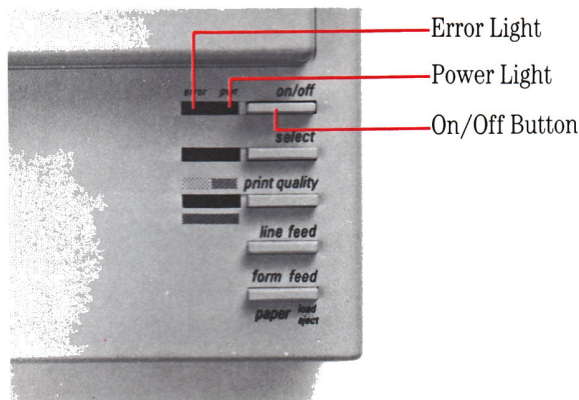

If nothing happens, check the following.

- Is the front cover in place?
- Press the On/Off button again. Is the **printer on now**?
- Check the power cord connections. Is **everything firmly plugged in**?
- Has anything interrupted power to the wall socket or **power strip**?
- Does your power strip have an on-off switch?

If you're still having problems, see Chapter 5, "General Troubleshooting."

Loading Paper

Pin-Feed Paper is also known as **fan-fold paper**, **continuous-form paper**, or **computer paper**.

This section shows you how to load either **pin-feed paper** or single sheets of paper. The vertical sides of pin-feed paper have holes punched through them and perforations between sheets. For the printer test, select the type of paper that you intend to use most often.

If you plan to use the ImageWriter II SheetFeeder, or multipart forms, envelopes, or labels most of the time, use a few sheets of typing paper for now. Chapter 4 covers loading and printing on multipart forms, envelopes, and labels.

If you're working with single sheets of paper, see the section titled "Loading Single Sheets of Paper."

Loading Pin-Feed Paper

A **forms tractor** is the device that transports pin-feed paper into the printer. Its basic parts include the two tractors (one for each set of pin holes), the rods that connect the two tractors, and a mechanism gearing the forms tractor to the printer.

Loading pin-feed paper for the first time takes three steps: adjusting the **tractors** to accommodate your paper width, setting the printer to pin feed instead of friction feed, and rolling the paper in.

1. Get out your pin-feed paper. If the lead sheet is torn, wrinkled, or otherwise flawed, tear it off at the next perforation to present a clean edge to the printer.
2. Lift up and remove the **back cover** to get to the forms tractor, the device that pulls paper into the printer. Set the cover aside. (See Figure 2-10.)

Figure 2-10. Removing the Back Cover

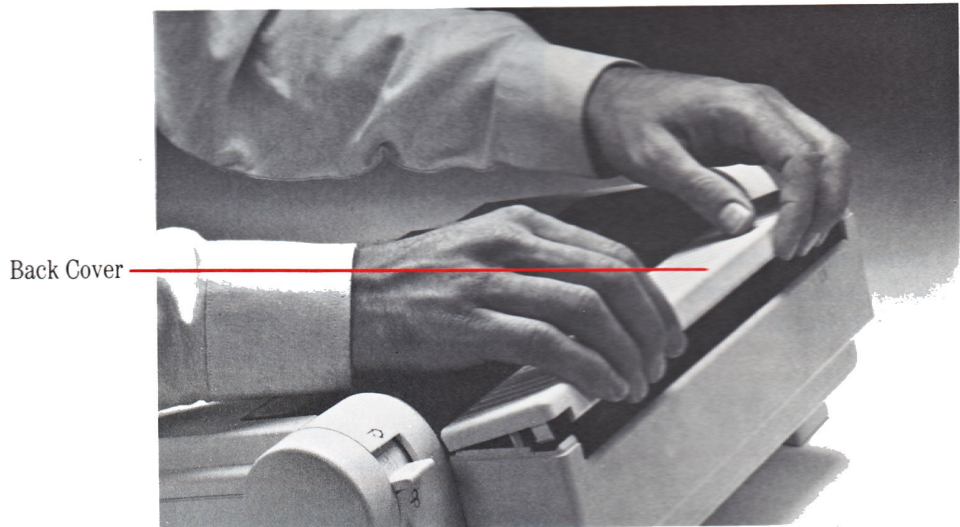

3. Flip open both **paper clamps** by lifting them in an outward direction. The clamps should spring into an upright position. (See Figure 2-11.)

Figure 2-11. Opening a Paper Clamp

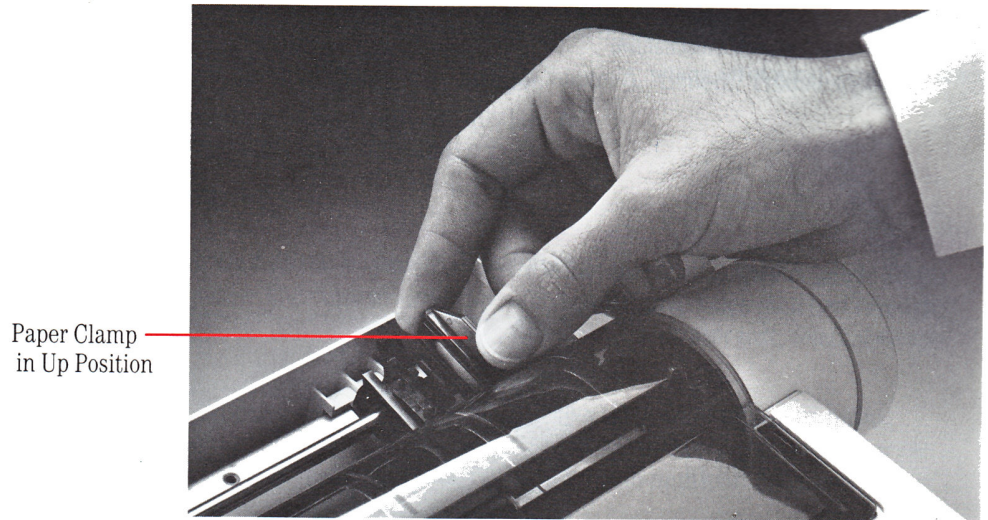

4. Flip the **tractor release levers** into the up position by pushing them toward the front of the printer. (See Figure 2-12.) This frees the tractors, the pinned belts that move the paper, so you can adjust them to the width of your paper.

Figure 2-12. Releasing a Tractor

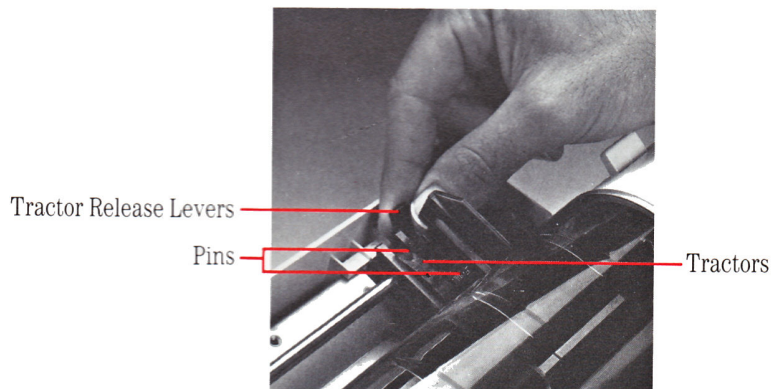

5. Lay down the lead sheet of paper so that the first three pins of the left-margin tractor poke through the first three pin holes. (See Figure 2-13.) Don't worry about the other side of the paper for the moment.

Figure 2-13. Loading Pin-Feed Paper

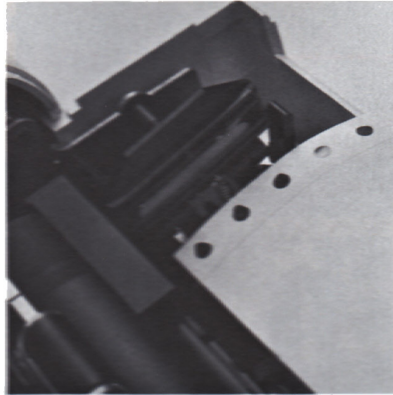

6. Close the left-margin paper clamp over the paper.
7. Find the **pin-feed alignment icon** on the back panel of the printer and the **alignment notch** directly above it. (See Figure 2-14.) Slide the tractor until the paper edge matches the icon's vertical line and the notch.

Figure 2-14. The Pin-Feed Alignment Icon

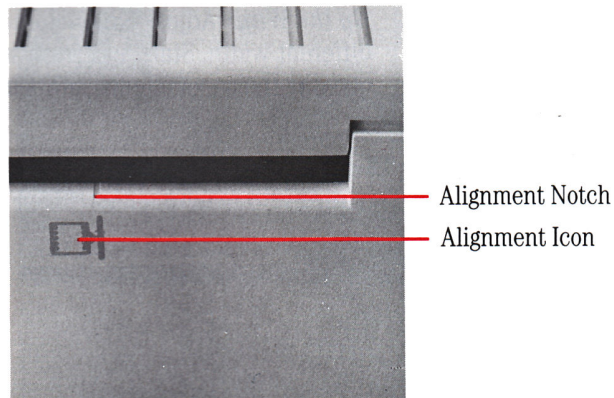

8. With the tractor and paper properly aligned, lock the left-margin tractor in place by pressing its lever into the down position.
9. Slide the other (right-margin) tractor so that its top three pins come up through the paper's first three holes.
10. Close the paper clamp and gently slide the tractor as far as necessary to take the slack out of the paper.
11. Press the right-margin tractor release lever into the down position. Figure 2-15 shows a properly aligned sheet of pin-feed paper.

Figure 2-15. Pin-Feed Paper on the Forms Tractor

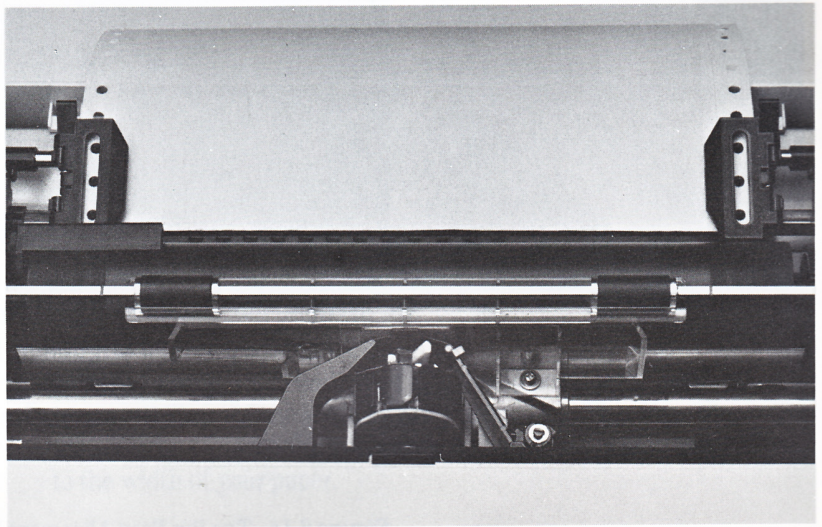

By the Way: Adjust the tractors only when you change to a paper with a different width. Starting a fresh stack of pin-feed paper involves only opening the paper clamps, dropping the paper onto the pins, and closing the clamps.

12. Set the **paper release lever** (located next to the **platen knob**) to the up position for pin feed. (See Figure 2-16.)

Figure 2-16. Paper Release Lever

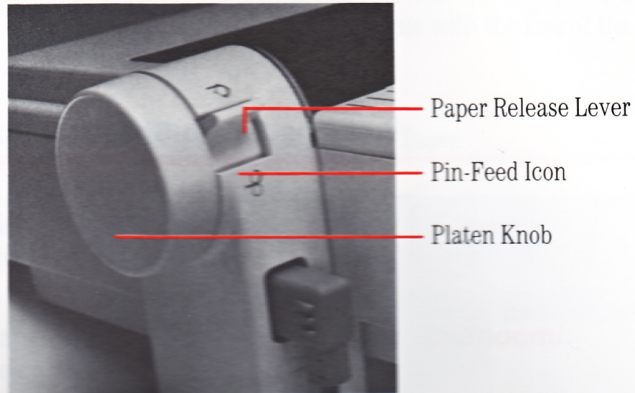

13. To load the paper into the printer, turn the platen knob clockwise until the leading edge of the paper comes up under the **paper bail**. (See Figure 2-17.)

Important!

With the top edge of the paper under the paper bail, printing will begin approximately one inch from the top of the paper. You may want to compensate for this in your printing **software**, which sets a **top margin** of its own. Chapter 4 gives some tips on resetting software top margins.

Figure 2-17. Paper Loaded Under the Paper Bail

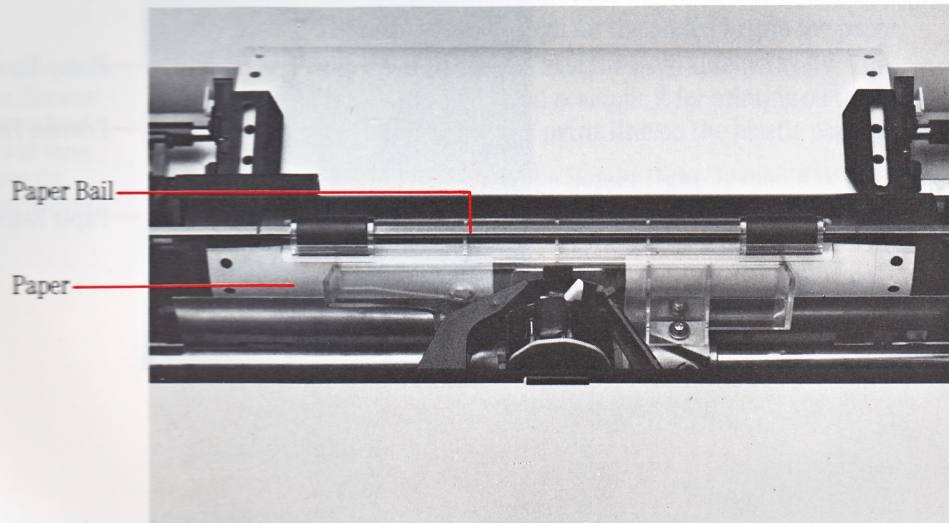

14. Put the back cover on.

When the paper is satisfactorily loaded, jump ahead to the section “Running the ImageWriter II Printer Self-Test” toward the end of this chapter.

Loading Single Sheets of Paper

When loading single sheets of paper, you can take advantage of the ImageWriter II’s automatic paper loading feature. Slip in a piece of paper, press a button, and the printer automatically positions the paper for printing to begin on the first line.

Important!

The ImageWriter II works best with 16- to 24-pound bond. If you need to work with lighter papers (like onionskin), be sure to insert one or more backup sheets to provide enough thickness for the friction-feed mechanism.

▲Warning

Do not use paper with staples or paper clips in your ImageWriter II.

To load your test sheet of paper, follow these steps.

1. Set the paper release lever (located next to the platen knob) to the down position for friction feed. (See Figure 2-18.) Choosing friction feed turns off the pin-feed mechanism.

Figure 2-18. Paper Release Lever Set for Friction Feed

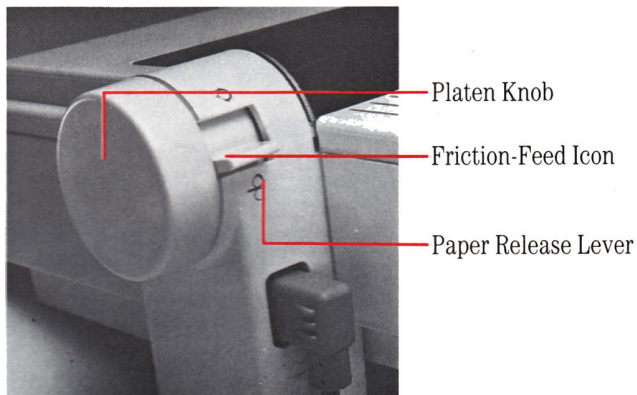

2. Slip the sheet of paper between the back cover and **platen**.
3. Find the single-sheet icon located near the left side of the back cover and place the paper so that it aligns with the line of the icon. (See Figure 2-19.)

Figure 2-19. Aligning a Single Sheet of Paper

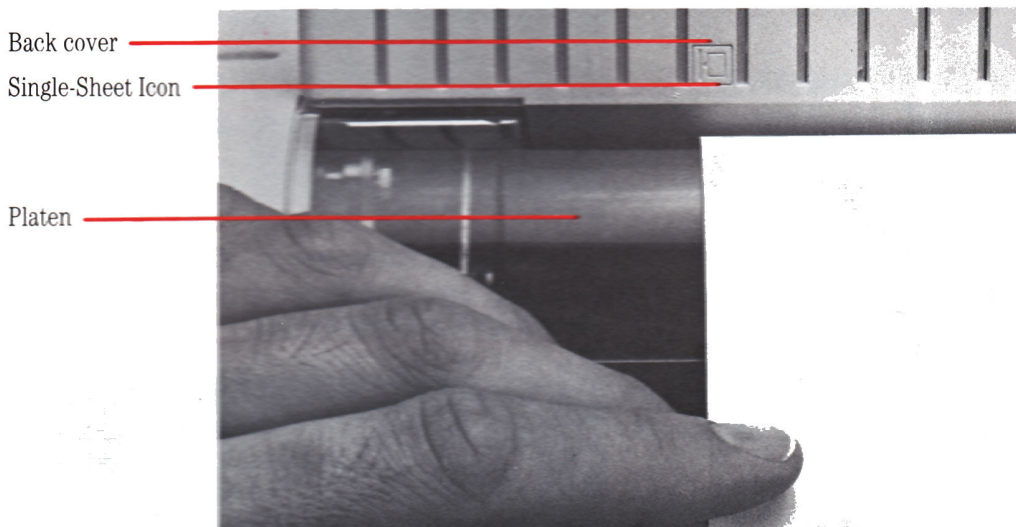

4. Make sure that the paper is straight (just as you do when putting paper in a typewriter) and in deep enough for the platen to grip the paper.
5. Press the **Form Feed button** to load the page automatically. The ImageWriter II rolls the paper and positions it for printing on the first line of the page (indicated by the **print line** on the plastic paper guide).

If the paper doesn't load, check the **Select light**. It should be off. If the Select light is on, press the **Select button** and then the Form Feed button.

By the Way: Although most people prefer automatic paper loading, you can crank the paper in by hand with the platen knob.

A **form feed** is a printer action that pushes paper to the top of the next page. Because this action can **eject an old page or load paper**, the control cluster bears all three labels. However, this manual uses the single term *form feed* for ease of reading.

Figure 2-20. The Select and Form Feed Buttons

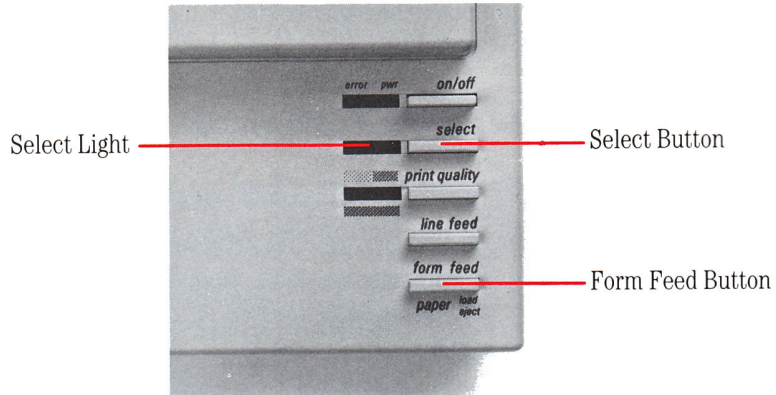
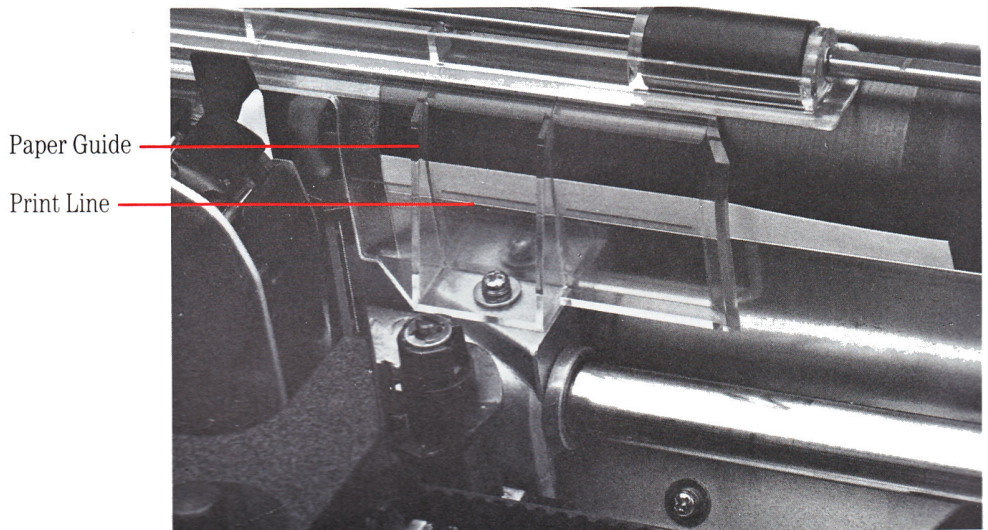

Figure 2-21. The Print Line



Running the ImageWriter II Self-Test

Now that you **have correctly** loaded paper into your ImageWriter II, you're ready to run its **self-test**—a repeated printing of the ImageWriter II **character set**. When your ImageWriter II passes the test, you will know that **any problems that might arise** have developed in the software, the computer, or in the connection between the computer and printer.

Color Testing: If you have installed the color ribbon, this test will print all the colors the ImageWriter II can generate.

1. Turn the ImageWriter II off by pressing the On/Off button.
2. To start the self-test, press the Form Feed button and hold it down while you press the On/Off button. Release both buttons when the print head moves. (The printing test won't begin until you release the buttons.)
3. To stop the self-test, press the On/Off button to turn the printer off.
4. If you loaded a single sheet of paper, roll the test page out by turning the platen knob.
5. If you have loaded pin-feed paper, roll the paper forward to position the perforation under the paper bail. This ensures that when you turn the printer back on, printing will begin an inch from the top. Tear off the test sheet.

Examine the **printout** carefully.

- Are all characters complete?
- Are all characters well aligned?
- Is the spacing between characters and lines even?
- Are all the lines equally dark from beginning to end?

If you notice any problems, check this troubleshooting list to see if the ribbon is properly installed and the paper correctly loaded.

- Is the ribbon cartridge firmly seated in its carrier?
- Does the printing area of the ribbon lie between the ribbon guide and the paper guide?
- Is the ribbon loose?
- Is the paper straight?

Correct any problems and try the test again. If there's still a problem, see Chapter 5, "General Troubleshooting." If Chapter 5 doesn't help, contact your authorized Apple dealer.

What's Next

If your printer passed the test, you're ready to **connect it to your** Apple computer. If you have a Macintosh Plus, a **Macintosh**, **Apple IIc**, **Apple IIe**, **Apple II Plus**, or **Apple II**, see Chapter 3. If you have a **Macintosh XL**, **Lisa Office System**, or **Apple III**, see Appendix D.

Once you have connected your printer to your computer, **if you have an** **ImageWriter II SheetFeeder**, or intend to connect your **ImageWriter II to an** **AppleTalk** network, see the manuals for these products.

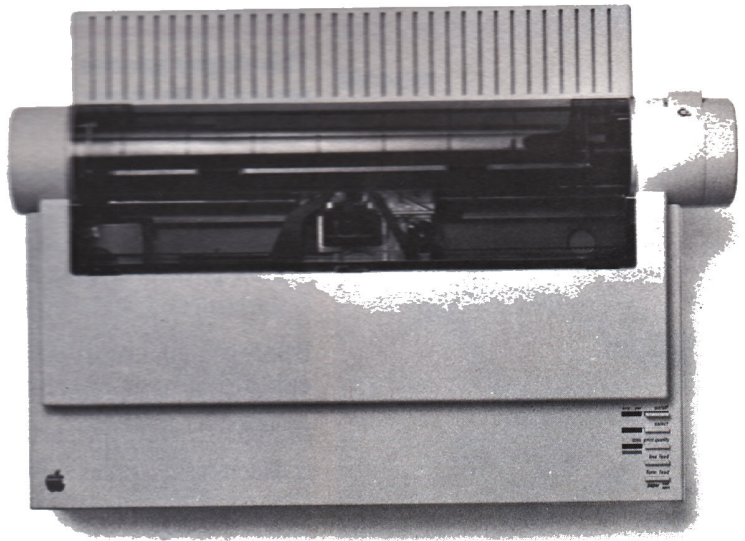

This chapter shows you how to connect the ImageWriter II to a Macintosh Plus, Macintosh, Apple IIc, Apple IIe, Apple II Plus, or Apple II computer and how to test the connection. Appendix D shows you how to connect the ImageWriter II to the Macintosh XL, the Lisa Office System, and the Apple III.

The test verifies that the computer can send data to the printer and that the printer can print the data. This means that if a problem arises, you can trace the trouble to two *probable* areas: a loose connection or an improperly configured program (a word processor or **spreadsheet**, for example).

Before You Begin

This chapter assumes that you have installed the printer ribbon and loaded paper into the printer. You should also have successfully self-tested the ImageWriter II.

By the Way: The computer or printer can develop problems, but such hardware failures are uncommon. If a problem arises, check the connections and software first. See Chapter 5, “General Troubleshooting.” If the problem persists, try to narrow the problem to either the printer or the computer, and then see an authorized Apple dealer.

Before continuing, check the part number on your Apple **serial interface cable** to make sure you have the correct cable for your computer.

- Apple System/Peripheral-8 Cable (for Macintosh Plus): Part No. M0187
- Macintosh Peripheral-8 Cable: Part No. M0185
- Apple IIc Peripheral-8 Cable: Part No. A2C4312
- Apple IIe Printer-8 Cable: Part No. A9C0313

Note: The Apple II and Apple II Plus take the same cable as the Apple IIe.

▲Warning

If your serial interface cable does not have the proper connectors, don't try to make it fit; see your authorized Apple dealer before continuing.

Figure 3-1. Apple Serial Interface Cables



Macintosh Plus



Macintosh



Apple IIc



Apple IIe, II Plus, and II

Important!

A **shielded cable** is a cable that uses a metallic wrap around the wires to reduce the potential effects of radio frequency interference.

Your Apple computer and its peripheral devices were FCC-certified under test conditions that include use of **shielded cables** and connectors between system components. It is important that you use shielded cables and connectors to reduce the possibility of causing interference to radio, television, and other electronic devices.

▲Warning

Always make sure you have turned off both the computer and a peripheral device, such as a printer, before connecting or disconnecting them. Changing cables when the power is on can damage your equipment.

Connecting the Printer Cable to the ImageWriter II

Locate the **8-pin, mini-circular connector** (shown in Figure 3-2) on your printer cable. The top side of the connector bears an **Apple** or a printer icon (for the Apple II, II Plus, and IIe).

Figure 3-2. The 8-Pin, Mini-Circular Connector



Plug the connector into the ImageWriter II's **serial interface socket**. (See Figure 3-3.) Make sure you get a firm fit. Loose connections can cause interference with radios and televisions, scramble data, or stop the printing process.

Figure 3-3. Plugging the Printer Cable Into the Printer

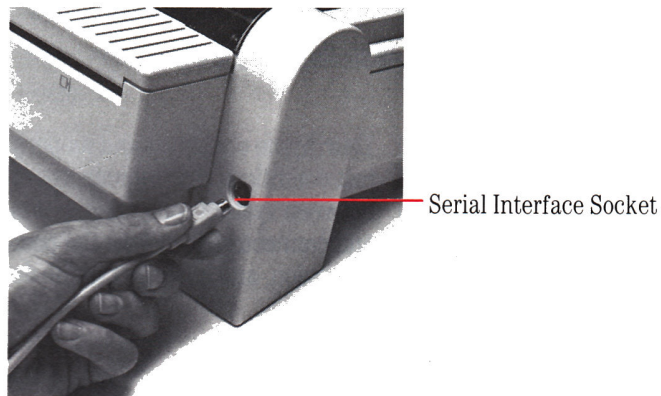

Find the section of this chapter that pertains to your computer. Installation instructions follow in this order:

- Macintosh and Macintosh Plus
- Apple IIc
- Apple II, II Plus, and IIe

If you're connecting the ImageWriter II to an AppleTalk network, see the documentation that comes with the ImageWriter II AppleTalk Option.

Connecting to the Macintosh Plus and Macintosh

To connect the ImageWriter II to the Macintosh Plus or Macintosh, follow these six steps. Macintosh Plus users should have performed the steps in the section "Using the Installer" in *Macintosh Plus*, the owner's guide, before connecting to the ImageWriter II.

1. Insert the free end of the data cable into the printer port. (See Figure 3-4.) If you have a Macintosh 128K or Macintosh 512K, tighten the connector's thumbscrews for a secure connection.

Figure 3-4. Connecting the Printer Cable to the Macintosh Printer Port

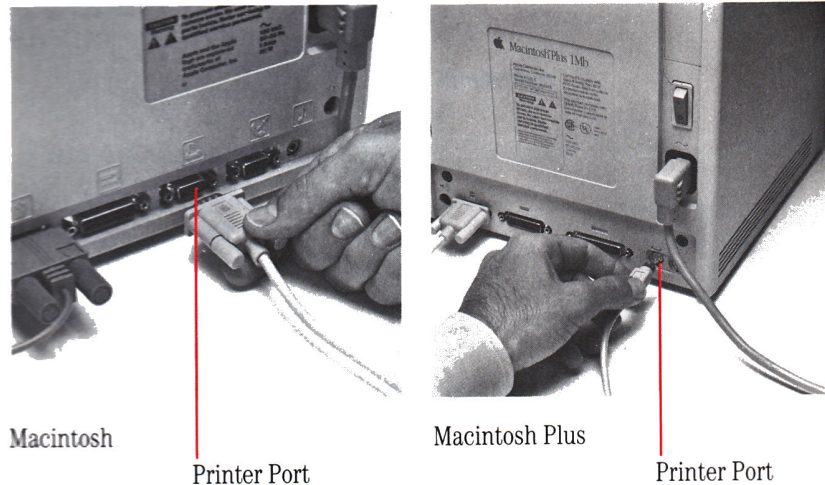

2. If another connector (such as AppleTalk) occupies the printer port, connect to another port, for instance the modem port.
3. Make sure you have a startup disk in the drive, and turn on the computer.

4. Turn the printer on and make sure the **Select light is on**.
5. Pull down the  menu. If you see the **Choose Printer accessory**, connect or disconnect AppleTalk as appropriate. Then select the device and/or port icon that matches your system.

If you see the Chooser accessory, first open the **Control Panel** to connect or disconnect AppleTalk. Then select the Chooser to set the appropriate device and/or port icon. If you need help with these procedures, see your owner's guide for details.

By the Way: After making printer software choices, you may want to look at the Page Setup in the File menu to check the printer's name and other settings.

6. To test the ImageWriter II connection, press **[CAPS LOCK]** into its down position. Then hold down the Command key and **[SHIFT]** while you press **[4]**. Your ImageWriter II should start printing the contents of the current screen.

If it does not, see the next section, "Solving Printer Software Problems," and, if necessary, Chapter 5, "General Troubleshooting."

Solving Printer Software Problems

If you have a problem with your printer, check all your connections and make sure the printer is on and selected. If these things are okay, you probably have a software problem. Read the section below that pertains to your computer.

Macintosh Plus Software

Open the Control panel in the  menu. Is AppleTalk connected or disconnected? Then select the Chooser from the same menu. Have you selected the correct printer and port icons?

If you see the Choose Printer instead of the Chooser accessory on the  menu, you haven't installed the right software on the current startup disk. To fix the problem, follow the instructions in the section "Using the Installer" in *Macintosh Plus*, the owner's guide.

Important!

Do not drag icons or use the Font D/A Mover to install printer software or the Chooser; run the Installer program.

Macintosh 128K and Macintosh 512K Software

Go back to step 5 to make sure you've selected the correct status for AppleTalk (Connected or Disconnected), and the appropriate printer and port icons.



Second, make sure you have a recent ImageWriter II printer resource; open the System Folder. If the ImageWriter II icon looks like either of the ones shown in the margin, you're ready to print. If you have a different ImageWriter II icon or no ImageWriter II icon at all, see your authorized Apple dealer for a software update.

Connecting to the Apple IIc

This is a very straightforward operation; just plug in and test.

1. Plug the connector firmly into the Apple IIc printer port. (See Figure 3-5.)

Figure 3-5. Plugging the Printer Cable Into the Apple IIc

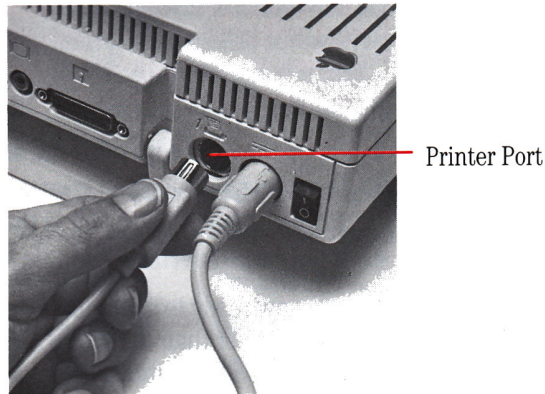

2. Now test the connection. Remove any disks from the disk drives.
3. Turn on the monitor.
4. Turn on the printer and make sure that the Select light is on.
5. Turn on the computer; ignore the "Check Disk Drive" message.
6. Press **CONTROL-RESET**. The Applesoft prompt appears: **1.**
7. To send keyboard **output** to the printer, type **PR# 1** and press **RETURN**.

When you type on the keyboard, your Apple normally sends the keyboard's **output** (characters) to the screen. You can, however, send these printers to other devices (a screen is a device). Here, typing **PR# 1** sends the characters to the printer.

8. Type any characters you want; **This is a test will do.** Note: These characters will not appear on the screen. Press **RETURN** to send this message to the printer.

The ImageWriter II should respond by printing the characters you typed and the words "SYNTAX ERROR." Don't worry about the error message. If the message printed, the connection passed the test. If nothing happened, see Chapter 5, "General Troubleshooting."

9. To return output to the screen, press **CONTROL-RESET**.

Connecting to the Apple II, II Plus, or IIe

Connecting the ImageWriter II to an Apple II, II Plus, or IIe requires configuring and installing a **serial interface** card. The following section tells you how to configure the Apple Super Serial Card™. See Appendix E for information on configuring other serial cards. Once the card is properly configured, you can connect the ImageWriter II to your computer and test the connection. Follow these steps.

1. Turn off your computer, but do not unplug it.

▲Warning

Never open your computer, handle its circuitry, or install an interface card, unless you have turned off the computer's power switch. This is important; you could damage your computer and interface cards by working inside the computer while the power is on.

2. Grasp the back edge of the lid and lift up. Set the lid aside.
3. Discharge any static electricity you may have collected by touching the power supply (the big box in the rear left corner of the computer).
4. If the serial interface card is in your Apple, remove it.

You are now ready to configure your serial interface card. If you have a serial card other than the Apple Super Serial Card, see Appendix E for configuration information.

Configuring the Apple Super Serial Card

Configuring the Super Serial Card takes two steps: setting the jumper **block** and setting the **DIP switches**. See Figure 3-6, and the *Apple II Super Serial Card User's Manual*.

Figure 3-6. The Apple Super Serial Card

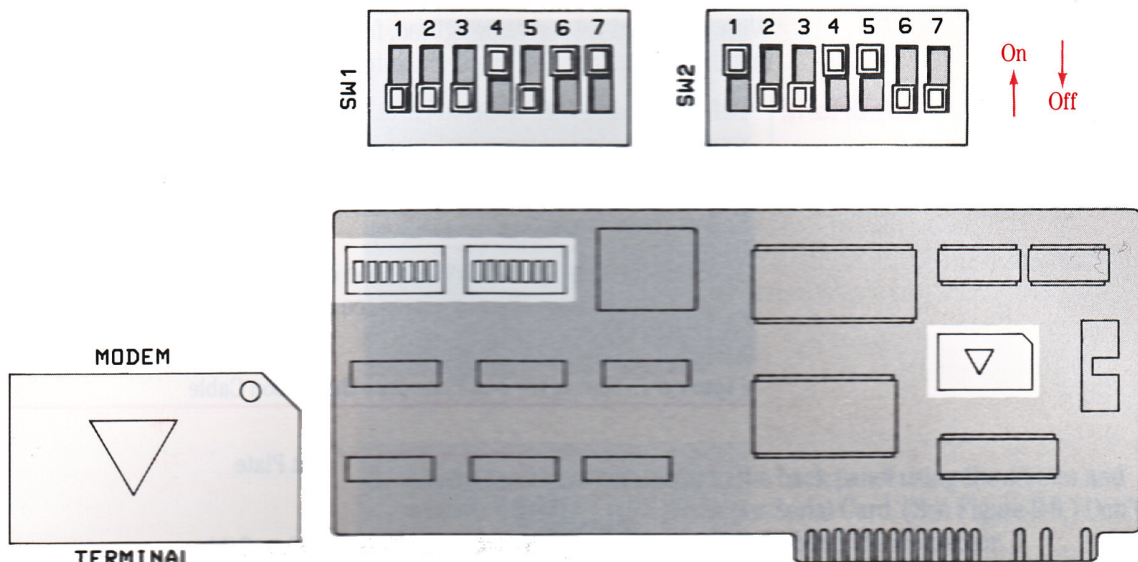

1. Make sure that the triangle-shaped mark on the jumper block points to **TERMINAL**. If it does not, gently unplug the block from the card (using a flat-bladed screwdriver or a chip puller), rotate it accordingly, and plug it back into the card.
2. Set the switches as indicated in Table 3-1.

Table 3-1. Super Serial Card Switch Settings

Note: On some Super Serial Cards, Open is the same as Off; Closed is On.

Switch 1	Function	Switch 2	Function
1 Open	9600 Baud	1 Closed	8 Data, 1 Stop Bit
2 Open	9600 Baud	2 Open	No Delay
3 Open	9600 Baud	3 Open	Line Width 80/ Video off
4 Closed	9600 Baud	4 Closed	
5 Open	Printer Mode	5 Closed	Lf after CR
6 Closed	Printer Mode	6 Open	Interrupts off
7 Closed	Normal CTS	7 Open	Normal CTS

Installing and Connecting the Serial Interface Card

With your card properly configured, follow the instructions in this section to install the card, connect the serial interface cable, and test the connection.

Important! Before working with internal parts, turn off the computer's power switch, remove the computer's cover, and touch the power supply case to discharge any static electricity that has accumulated on your clothes or body.

Follow these steps:

1. Slide the nut plate onto the ribbon cable as shown in Figure 3-7. Make sure the nuts on the nut plate face *away* from the 25-pin connector.

Figure 3-7. Sliding the Nut Plate Onto the Ribbon Cable

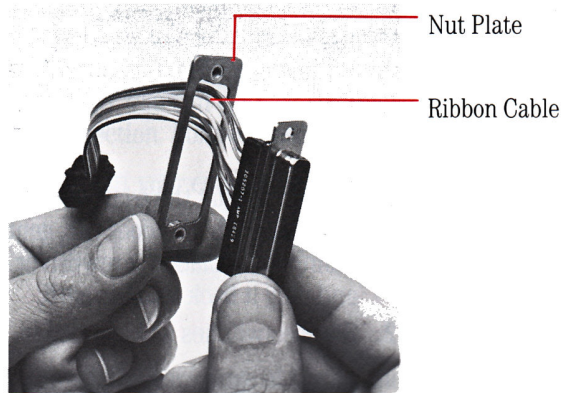

2. Hold the connector and nut plate up to one of the large openings in the back panel as shown in Figure 3-8. It's best to choose one of the openings near slot 1.

Figure 3-8. Positioning the Connector and the Nut Plate

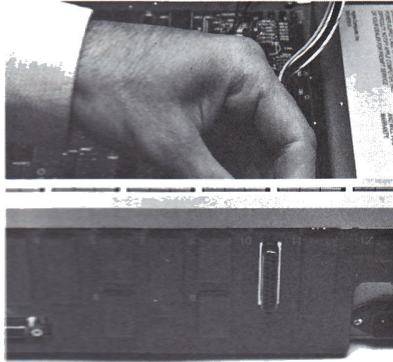

- 3.** Attach the 25-pin connector to the back panel using the screws and wrench that came with the Super Serial Card. (See Figure 3-9.) Don't overtighten the screws or you could bend the connector.

Figure 3-9. Attaching the Connector to the Back Panel

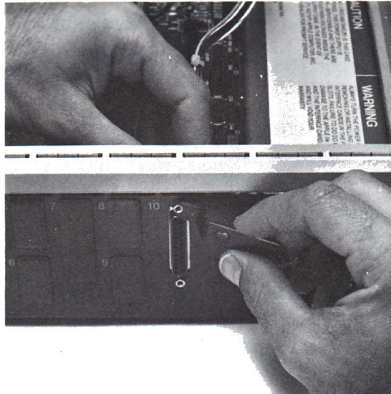

Apple II, Apple II Plus: If you are connecting your Super Serial Card to an Apple II or an Apple II Plus, you'll need a special clamp to attach the cable to the back panel. Ask your dealer for service parts 805-0084 and 805-0085.

4. Connect the ribbon cable to the **Super Serial Card** as shown in Figure 3-10.

Figure 3-10. Connecting the Ribbon Cable to the Card

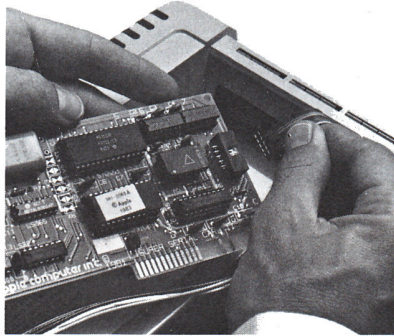

5. Put the card in slot 1. Install the card by rocking from back to front as shown in Figure 3-11. Don't rock it from side to side, and don't touch the gold "fingers" along the bottom edge of the card.

Figure 3-11. Installing the Super Serial Card in Slot 1

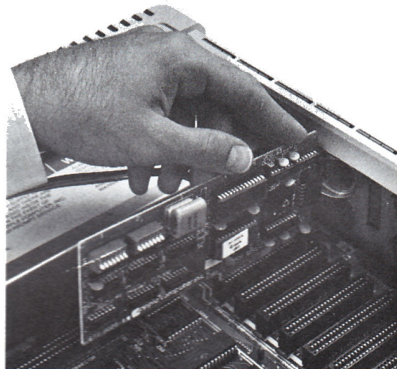

6. Connect the cable from your printer to the connector attached to the back panel of your computer.
7. Replace the cover.

Testing the Connection

Follow these steps to test the connection:

1. Make sure that drive 1 is *empty*.
2. Turn on the monitor.
3. Turn on the printer and make sure that its Select light is on.
4. Turn on the computer.
5. If your Apple automatically starts the disk drive, press **CONTROL-RESET** to stop the disk drive and put a BASIC language prompt on the screen—a **1** for Applesoft or a **>** for **Integer BASIC**.

If you have an Apple II without an Auto-Start ROM, press **RESET**
CONTROL-B **RETURN** to bring the Integer BASIC prompt to the screen.

6. To send the keyboard output to the printer, type **PR#1**. (If you put the printer card in a slot other than slot 1, type that slot number instead. For example, **PR#2** if you put the card in slot 2.) Press **RETURN**.
7. Type any characters you want; **This is a test will do**. Press **RETURN** to send this message to the printer. Because you are sending characters to the printer, your typing will not appear on the screen.

The ImageWriter II should respond by printing the characters you typed and the words "SYNTAX ERROR." Don't worry about the error message. If your message printed, the connection passed the test. If it didn't, see Chapter 5, "General Troubleshooting."

8. To return output to the screen, press **CONTROL-RESET**.

When you type on the keyboard, your Apple computer normally sends the keyboard's output (characters) to the screen. You can, however, send these characters to other devices (a screen is a device). Here, typing **PR#1** sends the characters to the printer.

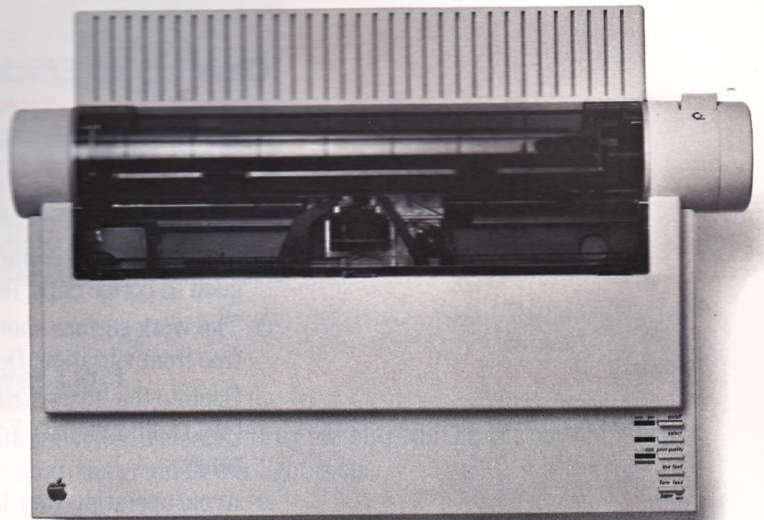

This chapter describes how to

- create an efficient working environment for the ImageWriter II
- use the control panel
- find and set top of form
- get the last page out of the ImageWriter II
- print color graphics
- load multipart forms, envelopes, and address labels

You'll also find tips on using ImageWriter II accessories.

Creating an Efficient Working Environment

Here are some points to keep in mind when creating an efficient working environment.

- Keep your ImageWriter II out of direct sunlight.
- Place it away from chemical fumes and containers filled with liquids—such as coffee cups, flower vases, and so on.
- The work surface should be sturdy, stable (no card tables, please), and free from vibration. Desks, file cabinets, and printer stands work well.
- Operate the ImageWriter II in temperatures from 50° to 104° Fahrenheit (10° to 40° Celcius). You should not attempt to operate it outside this range.
- Avoid operating your ImageWriter II when the relative, noncondensing humidity goes beyond the 20% to 95% range or store it where relative, noncondensing humidity exceeds the 10% to 95% range.

If you use pin-feed paper, consider where to store it. If you use small amounts of paper, slide the stack of paper under the ImageWriter II. The area under the printer can accommodate up to 200 pages of 16-pound bond. Position larger quantities so that they flow easily to the printer.

▲Warning

Do not push the paper too far under the printer or try to store too much paper under it. Either practice can cause jamming.

Place the printer so that printed pages fall away from the printer. Piled-up pages can cause printer jams or unevenly printed lines.

Control Panel Details

This section shows you how to work with the various buttons and lights on the ImageWriter II control panel, shown in Figure 4-1.

Figure 4-1. The ImageWriter II Control Panel

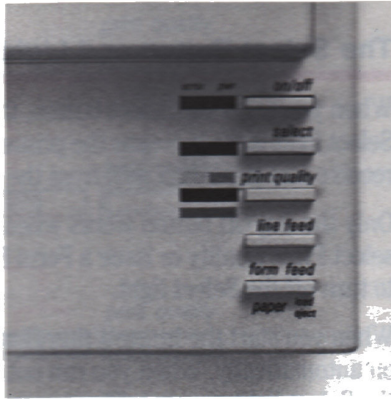

The Power Light

Turn the ImageWriter II on and off by pressing the On/Off button. When the printer is on, the green Power light is on.

The Error Light

The Error light can light in three ways: continuously on, blinking, or irregular blinking. Each state indicates a different problem area.

When the Error light is on continuously, the ImageWriter II has run out of paper. Load the appropriate paper and press the Select button to continue printing.

When the Error light blinks on and off, look for either of two causes. The front cover may be loose or off. Correctly seat it and press the Select button to continue. If the front cover is not the cause, check for paper or print mechanism jams.

When the Error light blinks irregularly, check DIP switch SW2-4, located toward the front-left corner of the printer. (You may have to slide the ribbon cartridge to the right to see the DIP switches.) If you don't have an accessory card (either the ImageWriter II 32K Memory Option or AppleTalk Option), the switch should be set to Open. If you have either of these options installed, the switch should be Closed. See Appendix A for details on DIP switch settings.

The Select Button and Light

When you press the Select button, the Select light turns on or off. When the Select light is on, it means the printer is *selected*. That is, the printer can receive and print data sent from the computer.

Only the On/Off button works when the Select light is on. To do things like select Print Quality or issue a Form Feed, you must press the Select button to turn off the Select light.

When you start the ImageWriter II with paper loaded, the Select light comes on automatically. When you run out of paper, the Error light comes on and the Select light goes out. The computer then stops sending data and the printer stops printing. After you add more paper, you can resume printing without losing any **text**. To resume printing, press the Select button to reselect the printer.

By the Way: When the Select light goes out because you've run out of paper, you can press the Select button without loading more paper. Each time you press the Select button, one line will print. You can squeeze several more lines onto a page, but be careful of printing on a bare platen.

Selecting Print Quality

The ImageWriter II has three levels of print quality:

- 1. Draft:** high speed (250 characters per second) for printing the least dense characters. Choose draft quality when you want a printout quickly for reviewing or editing.
- 2. Standard:** medium speed (180 characters per second) and character density. Standard quality is good for everyday work.
- 3. Near Letter Quality (NLQ):** (45 characters per second) high density characters for presentations and formal communications.

Make sure the Select light is *off* before selecting a print quality. (If the light is on, press the Select button.)

By pressing the Print Quality button repeatedly, you can “walk” through the three settings. Figure 4-2 shows the selection in terms of the lights.

Figure 4-2. Print Quality Selection Lights

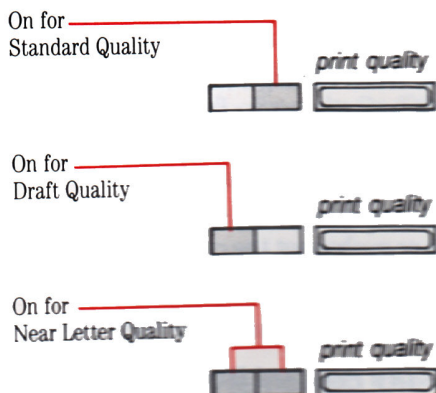

When only the left light is on, you get draft quality. When the right light is on, quality is standard. Both lights on means near letter quality.

Important for Macintosh Plus and Macintosh Owners: Choosing either Standard or High quality in the Print command dialog box **overrides** any quality setting on the printer. However, if you choose Draft quality in the dialog box, the quality will be that currently selected at the printer—either draft, standard, or NLQ.

The Line Feed Button

Pressing the Line Feed button once and immediately releasing it advances the paper by one line. If you press and hold down the Line Feed button, the printer will perform repeated line feeds up to four times. After the fourth **line feed**, the printer automatically performs a form feed. When the Select light is on, pressing the Line Feed button has no effect.

The Form Feed/Paper Load/Eject Button

The Form Feed button has three names to remind you of its three related functions:

- 1. Form Feed.** When using pin-feed paper, pressing the **Form Feed** button advances the paper to the next top-of-form position. That is, it feeds in a new “form,” or page, and positions it so that printing can begin on the first line of the page.
- 2. Paper Load.** When loading a single sheet of paper, pressing the **Form Feed** button causes the printer to load the sheet with its top of form set 1/6 inch below the top edge of the paper. In this position, printing begins on the first line of the page.
- 3. Eject.** When a print job finishes in mid-page, pressing the **Form Feed** button ejects or pushes out the current page. If you’re using pin-feed paper, the printer advances the paper to the next top-of-form position.

When the Select light is on, pressing the Form Feed button has no effect.

Single Sheets in a Pin-Feed World: If you’re using pin-feed paper and find you have to use a single sheet of paper, don’t despair. Back the pin-feed paper out from under the platen, but leave it clamped in the forms tractor. Switch the paper release lever to friction feed, and then load your single sheet of paper.

Pin-Feed Paper and Top of Form

The term **top of form** describes where the printer will print its first line on a page. With the ImageWriter II, the top of form is the position of the print line *relative* to the top edge of the paper when you turn on the printer. Thus, if the print line rests 1/6 inch below the top edge of the paper, that is the top of form.

When you print through an **application program** like MacWrite® or AppleWorks, the program keeps track of the number of lines it has printed on the current page. When the count reaches the maximum number of lines, the software issues a form feed and the paper advances to the top of the next page. The printer itself can also keep track of the number of lines printed or line feeds issued.

You can throw off the line count by advancing or loading paper independently of the software. For example, if you cause printing to pause and then advance the paper (either manually or by pressing the **Line Feed**

button), the software won't register that you've set a new paper position. The result is that the next page break will occur somewhere in the middle of the page instead of at the end of a page.

Because the printer sets the top of form when you turn the printer on, you can easily set a desired top of form. Follow these steps.

1. Press the **On/Off** button to turn off the printer.
2. Turn the **platen knob** to advance the paper to the desired top-of-form position.
3. Press the **On/Off** button again to restart the printer and establish the new top-of-form position.

***By the Way:** When you're unsure if you're looking at a true top of form, turn off the printer, pause, and turn it back on. The current position of the print line is the true top of form.*

Removing the Last Pin-Feed Page

If you're working with pin-feed paper, notice that when a print job ends, some of the last page remains inside the printer. Choose any of three ways to make it easier to tear off the last page.

1. Preset top of form so that the top of the page lies just above the paper bail.
2. Eject the page with a form feed.
3. Leave the last page of the document in the printer.

▲Warning

Don't print within 1/2 inch of any of the four corners of a sheet of paper. Printing too close to a corner can tear the corner or even jam the printer.

Preset Top of Form

This method requires some experimenting with the program that prints your documents. You must change the program's **top margin** setting. The top margin is the distance from the top edge of the paper to the first line of text on the page. To set top of form for easy paper removal, follow these steps.

1. Set your top of form so that the top edge of page lies just above the paper bail.
2. Set the top margin *one inch less* than it is currently set. For example, if it's set to one inch (or six lines), change it to zero. If it's set to 1.5 inches, set it to .5. If you don't reduce your setting, the cost will be an extra inch at the top of every page.
3. To compensate for the changed top margin, set the bottom margin one inch *more* than its current setting.
4. Print a brief document from your program to test the setting. If all goes well, the perforation following the last page will stop just past the bail, making it easy to tear off the last page.

If the printout shows a smaller or larger top margin than you like, change the **top** and **bottom** margin settings and try again.

Figure 4-3. Tearing Off a Page

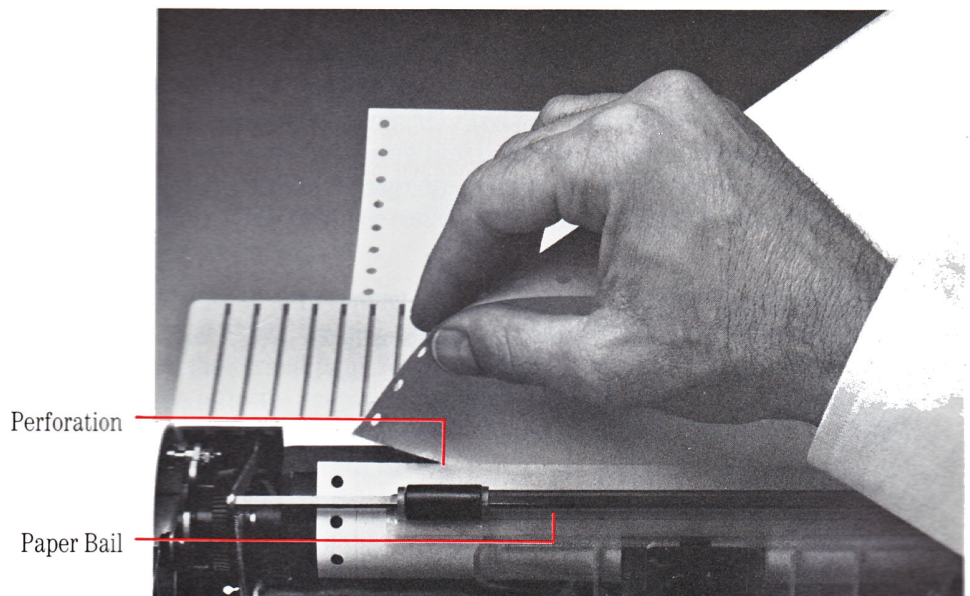

Eject the Last Page

To eject the last page, follow these steps.

1. Make sure the Select light is out.
2. Press the Form Feed button once to eject the current page.
3. Tear off the last page at the perforation.

By the Way: You may want to save blank, ejected sheets of pin-feed paper to use as scratch paper.

Leave the Last Page in the Printer

This works pretty well, particularly if you make multiple copies of your work. Just remove the last page after you've printed another document. When you need that last page, eject it.

Printing in Color

To print in color, you need a program that can send color commands to an ImageWriter II. The **default** color for the ImageWriter II is black, and only color software can make it print differently. See Appendix A for information on programming in color.

To print in color, install a color ribbon cartridge, just as you do a black ribbon. With the color ribbon installed, the ImageWriter II can print up to six colors plus black. With black as one of the ribbon's colors, you can mix your color graphics with black text. However, if you intend to print a text-only document, it's a good idea to switch to a black ribbon. This preserves the black band on the color ribbon.

Although the ImageWriter II is factory set to print colors in a properly aligned manner, occasionally a ribbon will need a slight adjustment. For example, you might see an underline character printing in a different color from the text above it or see the tops of characters in a different color from the rest of the characters. If you encounter problems like these, see the section "Color Ribbon Problems" in Chapter 5, "General Troubleshooting."

Loading Forms, Labels, and Envelopes

To print on multipart forms and envelopes, you need to adjust the printer for thicker paper.

Adjusting for Paper Thickness

To adjust for thicker paper, you need to set the **paper thickness lever**. In its standard (up) position, the lever sets a thickness for one sheet of paper (16- to 24-pound bond). The lever clicks through four positions. You can change to the second position by pushing the lever downward. The second position is for a two-sheet thickness. The next position is for three sheets and the last for four.

▲Warning

Never use a form, label, or envelope that is thicker than four sheets of 16-pound bond. Too much paper may cause lines to register incorrectly or may jam the printer.

Follow these steps to set the lever.

1. To get at the lever, remove the front cover. The lever is at the right end of the carrier rod.

Figure 4-4. The Paper Thickness Lever

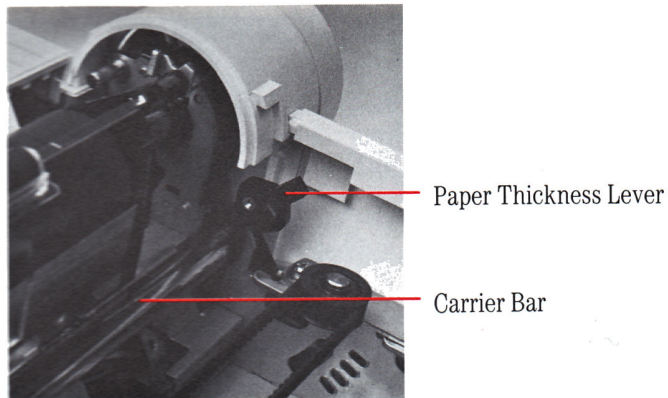

2. Before setting the lever, count the sheets in an individual form. For envelopes, try a two-sheet thickness, and for mailing labels, a three-sheet thickness.
3. Click the lever to the appropriate setting.
4. After adjusting the paper thickness lever, replace the front cover. If the cover is off or not properly seated, the ImageWriter II will not print.

Finding the Correct Forms Tractor Setting

When working with pin-feed forms or labels, you may have to adjust the tractors. See Chapter 2 for an explanation of how to adjust the tractors.

Before you adjust the tractors, a little experimentation is in order; follow these steps.

1. Make a test run on ordinary, pin-feed paper. Print your form or a few labels to determine where the program sets the left margin. Use the pin-feed icon to help you align the form or label sheet.
2. Set the left tractor so that the point where you want to begin printing on your form or label corresponds with the left margin actually delivered by the program.

By the Way: If the Error light comes on, signifying paper out, you may have set the left tractor too far to the right. Readjust the tractor and try again.

Important!

Don't try to set the margins beyond the red rings on the paper bail. These rings represent the print head's absolute boundaries.

3. With the left tractor set, use your form or label sheet to set the appropriate position for the right tractor.

▲Warning

When using labels, do not turn the platen knob counter-clockwise. This could cause a label to come off in the printer, possibly causing damage.

4. When you have finished your form or label printing, you may want to make a note on your sample printout page of the settings you used, for future reference. Be sure to reset paper thickness before reloading regular paper.

Loading Envelopes

Follow these steps to load and print envelopes.

1. Remove the front cover and set the **paper thickness lever** to the appropriate thickness.
2. Replace the front cover.
3. Set the feed lever to friction feed.
4. Remove or tip back the front cover window.
5. Lift up the paper bail until it locks into place. (See **Figure 4-5.**) This elevated position ensures that your envelopes won't jam in the bail during the printing process. Leave the bail in this position until you've finished printing your envelopes.

Figure 4-5. Setting the Paper Bail for Envelopes

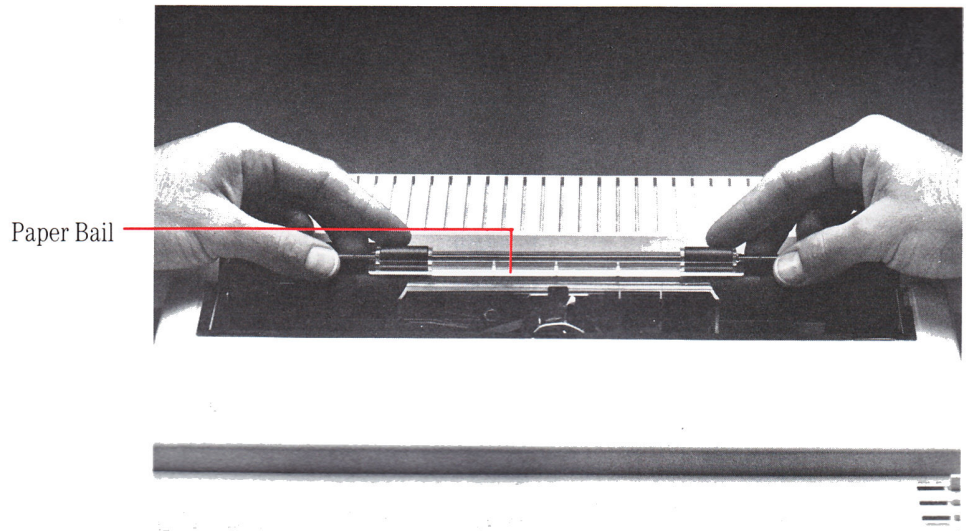

6. Align the envelope with the single-sheet icon on the back cover.
7. Turn the platen knob to draw the envelope into the desired position for printing.
8. Issue your software's print command.

9. If necessary, turn the platen knob to eject the envelope from the printer when printing stops.
10. When you are finished with envelopes, press gently on both sides of the paper bail to return it to its normal position.
11. Be sure to reset the paper thickness lever and, if necessary, the paper release lever before returning to normal printing.

ImageWriter II Accessories

This section gives tips on using three ImageWriter II accessories:

- ImageWriter II SheetFeeder
- ImageWriter II 32K Memory Option
- ImageWriter II AppleTalk Option

These are *tips*. For complete details on an accessory's operation, see the accessory's manual.

The ImageWriter II SheetFeeder

Before working with the ImageWriter II SheetFeeder, make sure that the paper release lever is in the friction-feed (down) position. Before loading a stack of paper, flip through the stack to loosen any pages that might be stuck together. Never load more than 100 sheets of paper at a time. See the *ImageWriter II SheetFeeder Installation Manual* for more information.

Note: You cannot use pin-feed paper when the ImageWriter II SheetFeeder is in place.

The ImageWriter II 32K Memory Option

The Memory Option has a 32,000-character memory, enough to handle documents from 16 to 20 pages long. With this option installed, issue your program's print command. The option takes care of the printing, while you and your computer tackle other projects.

Note for Macintosh Plus and Macintosh Users: In most cases, the Memory Option has no effect when working with a Macintosh Plus or Macintosh, because of the way these computers send data to the printer.

The ImageWriter II continues to print until it has processed all the characters in the option's memory. To pause while printing, press the Select button. Press it again to resume printing. If you need to cancel printing, turn off the printer, pause a few seconds, and turn it on again.

If the Memory Option doesn't seem to work, check DIP Switch SW2-4. It should be in the Closed position. See Appendix A for details on DIP switches.

The ImageWriter II AppleTalk Option

With the ImageWriter II AppleTalk Option installed, as many as 31 computers can share the same ImageWriter II. To enable the option, set DIP switch SW2-4 to Closed. To disable the AppleTalk Option, first unplug the AppleTalk cable from the printer. Then set SW2-4 to Open.

▲Warning

Do not install an ImageWriter II to an AppleTalk network without an AppleTalk card installed or without the card enabled. If you do, you will *disable* your entire AppleTalk network.

▲Warning

When disabling the AppleTalk Option, you must unplug from the AppleTalk network *before* resetting the DIP switch. Failure to unplug can stop the whole network from functioning.

You must configure your software to work on the AppleTalk network with the ImageWriter II. See your AppleTalk network and software documentation for more information. See Appendix A for details on DIP switches.

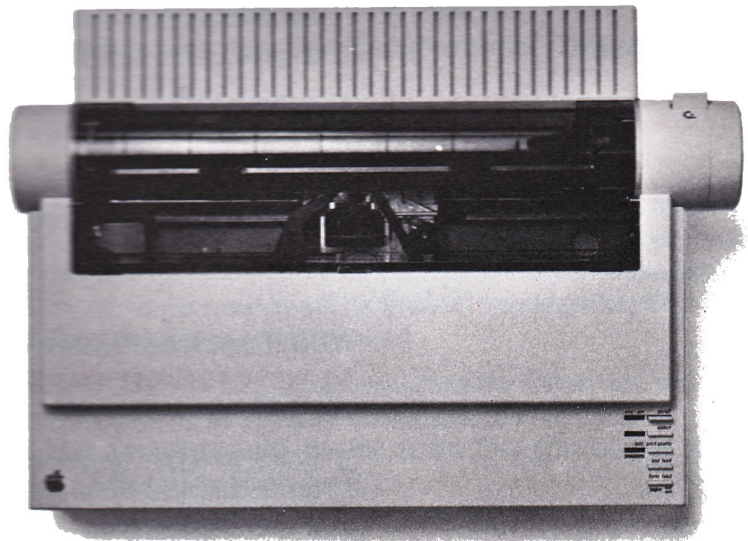

This chapter lists common problems and suggests solutions. Many problems are easy to solve—such as an unplugged power cord or having the Select button in the wrong position.

If there seems to be a more complex problem, run the printer's self-test. See the section "The ImageWriter II Self-Test" at the end of this chapter. If the self-test is successful, you'll know that the problem is **not with the printer**. The problem could be

- a poor connection or flaw in the serial interface cable and its connectors
- improperly configured software
- improperly set DIP switches in the printer
- a hardware failure, an improperly set jumper block, or DIP switches in the interface card (if the serial interface cable connects to one)
- a hardware failure in the computer.

Important!

Proper environment and maintenance can prevent many problems. See Chapter 6 for details on care and maintenance.

The following sections describe problems you might encounter and provide diagnostic instructions and possible solutions.

You Turn the Printer On and Nothing Happens

Check these potential problem sources:

- Is the power cord plugged in? Check the power cord connection to the printer and to its power outlet.
- If you're using a power strip, is it plugged in? Is it turned on?
- Is power available to the power outlet? You may want to try plugging something else into it, like a radio or lamp. If the appliance doesn't work, the problem probably lies somewhere in your electrical system. Is the outlet controlled by a wall switch? Is the problem a blown fuse or tripped circuit breaker?
- If you determine that the printer is properly plugged in and turned on and that power is available to its outlet (the test appliance works), the problem may be a blown fuse in the printer. Take the printer to your authorized Apple dealer for fuse replacement. (The fuse is internal and should be replaced only by an authorized Apple dealer.)

The Printer Is On, But Nothing Happens

Several things can cause this problem.

- Is the ImageWriter II Select light on? You must *select* the printer, or it cannot receive data from the computer.
- Is the ribbon properly installed? Is it jammed?
- Are you using the correct serial interface cable?
- Is your serial interface card jumper block set to **TERMINAL**?
- Are the data transmission rates between the printer and the software or between the printer and interface card correctly matched? (See the section “Mismatched Data Transmission Rates,” later in this chapter.)
- Is the printer correctly connected to the AppleTalk network?
- Is the interface cable plugged into the correct socket? The cable will fit into a modem socket.

▲Warning | Never adjust or change a cable or an interface card when the computer is on.

- If you are using a Macintosh Plus, Macintosh, or Macintosh XL computer, check the Chooser or Choose Printer accessories (whichever appears on your  menu). Make sure you’ve selected the correct printer and port. If you have the Chooser, also check the Control Panel to see whether AppleTalk is connected or disconnected.

Important! | If you have a Macintosh Plus, you should have the Chooser and not Choose Printer. If you do not have the Chooser, you need to install software on your startup disk. See the section “Using the Installer” in *Macintosh Plus*, the owner’s guide.

Error Light Problems

The red Error light's three states indicate three problem areas:

- The Error Light is On.

You are out of paper. Load a fresh supply of paper and press the **Select** button to print.

- The Error Light is Blinking.

There are two causes for the blinking Error light. The front cover may be loose or not on. Correctly seat the front cover and press the **Select** button to continue. If the front cover is not the cause, check to see if anything has jammed the print mechanism.

- The Error Light is Blinking Irregularly.

When the Error light blinks irregularly, take a look at DIP switch SW2-4, located toward the front-left corner of the printer. (You might have to slide the ribbon deck to the right to see the DIP switches.) If you don't have an accessory card (the ImageWriter II 32K Memory Option or AppleTalk Option), the switch should be set to Open. If you have either of these options installed, the switch should be Closed. See Appendix A for details on DIP switch settings.

You Get a Printout, But Nothing Like You Expected

Unexpected output, like odd spacing or garbled characters, is usually a result of mismatched settings between the printer and the software or between the printer and interface card settings. These mismatches can stem from

- incorrect configuring of an application program's settings
- incorrect DIP switch settings on the interface card
- incorrect DIP switch settings on the ImageWriter II

When diagnosing a problem, check for software problems before checking the DIP switches. Chances are the problem doesn't lie with the printer's switches, unless someone has reset them. The switches are **factory-set to** standard specifications. See Appendix A for details on standard DIP switch settings and how to change them.

Software problems happen when a program's settings are not the **same as** the printer's. The process of changing software settings is called **configuring**.

If you suspect a configuration problem, read the material on configuration in your application program manual and check it against the standard settings for the ImageWriter II in Appendixes A and C. If you find a discrepancy, reconfigure the program to match the printer's specifications.

You might also try printing something from a different program—one you know works. If it works and the problem program doesn't, you probably need to reconfigure the problem software.

Mismatched DIP switch settings can cause the same problems as misconfigured software. The switch settings program the printer or interface card to do certain things, like send data at a given data transmission rate, for example 9600 baud.

The ImageWriter II has two DIP switch blocks. Serial interface cards have their own DIP switch blocks. If you're using a Macintosh Plus, Macintosh, or Apple IIc, you need only concern yourself with the ImageWriter II's DIP switches.

Missing, Jumbled, or Random Characters

These problems are caused by mismatched baud rates or mismatched data byte information (including data byte length, parity, stop bit, and start bit settings).

Mismatched Data Transmission Rates

When the data transmission rate settings between devices are different, the printer can produce a garbled printout. The ImageWriter II is set to 9600 baud at the factory.

Switches SW2-1 and SW2-2 should be in the closed, or down, position. If you own a Macintosh Plus, Macintosh, or Apple IIc and are having a baud rate problem, check these switches.

If you have an Apple II, II Plus, or IIe, make sure your serial card is set to 9600 baud, unless you're using an Apple Serial Communications Card or other card set to 300 baud. If this is the case, you must reset the ImageWriter II to 300 baud to receive the signal. Switches SW2-1 and SW2-2 should both be open for 300 baud. Check your interface card manual for baud rate details.

▲Warning | Never adjust switches or work with an interface card when the computer is on. You could harm the computer and the interface card.

Mismatched Data Bytes

Data byte mismatches can occur through improper software and serial interface card settings. Data byte mismatches include mismatches for the

- data byte length
- start bit
- stop bit
- parity setting

The ImageWriter II is *permanently* set for an eight-bit data byte with one start bit, one stop bit, and no parity. Check your software settings for these categories. If you have an interface card, check its settings.

Intermittently Dropped or Random Characters

Mismatched **communications protocols** or a hardware failure (like a flawed connector or cable) can cause intermittent problems.

Communications protocols tell a computer when to send data and when to pause in sending. A protocol mismatch can cause intermittent loss of characters or intermittent garbage. The ImageWriter II is factory set for the **hardware handshake** (also known as **Data Terminal Ready** or DTR) protocol. DIP switch SW2-3 should be set to Open. Closing this switch results in the XON/XOFF protocol.

Check the protocol settings for your software and for your interface card (if you have one).

Spacing Problems

Did the printout show the entire document printing on one line? Did the printer double- or triple-space when you wanted single spacing? The problem is line feed. A line-feed character causes the printer to advance the paper one line every time your software sends a carriage return (meaning the end of a line).

If the whole document printed on one line, it means that no line-feed character was sent to advance the paper. Any of three entities can issue line feeds: the printer, the software, and the interface card (if you have one). If you want single-spaced documents as your standard, you must **set one and only one** of these entities to add a line feed after a carriage return.

The ImageWriter II's factory DIP switch setting suppresses the **adding of a line feed after a carriage return**. Switch SW1-8 should be set to **Open**. **If your system uses an interface card**, set the interface card to add the line feeds. **If your system does not print through an interface card** (Macintosh Plus, Macintosh, or Apple IIc), or if you don't want to reset the card, set your software to send the line feed. Some software cannot do this, in which case **you will have to reset switch SW1-8 to the Closed position to send a line feed after a carriage return**.

If you have unwanted double spacing, then the printer is receiving two line feeds for each carriage return. Suppress one line feed as appropriate to your system. **If you have triple spacing**, suppress line feeds at two points (preferably at the printer and the software).

Paper and Print Quality Problems

If characters don't print clearly or start to look lighter with each line, check the following:

- 1.** Is your ribbon cartridge correctly mounted?
- 2.** Have you correctly threaded the ribbon between the ribbon guard and print head?
- 3.** Is the paper thickness lever set to the appropriate position? An incorrect setting can cause a poor impression (including missing dots).
- 4.** Is the ribbon worn out?
- 5.** Did printing take place across the ribbon seam? When the printer types across the ribbon seam, characters will print lighter for a line or so.

If the paper is feeding incorrectly, make sure that you've set the paper release lever to friction feed (the down position). Also, make sure that you are not inserting pages at an angle. If you are using the SheetFeeder with the ImageWriter II and have paper problems, see the *ImageWriter II SheetFeeder Installation Manual*.

Color Ribbon Problems

On occasion, an unwanted color may show up in a printout. Typically, this can be something like an underscore character appearing in a different color than the text directly above it. Three things can cause this problem:

- The ribbon cartridge is not firmly in position on the ribbon cartridge deck. Press down on the cartridge to make sure it is secure. If you hear the cartridge click into position, you may have solved the problem.
- The color ribbon is old. Older ribbons tend to “bleed” colors across color boundaries. Replace the ribbon with a new one.
- The ribbon cartridge itself is not quite properly aligned to the print head. This peculiarity of individual ribbons happens occasionally. To correct this problem, follow these five steps:
 1. Remove the cover from the ImageWriter and locate the **ribbon adjustment assembly** to the right of the ribbon cartridge. See Figure 5-1. Notice the two position markers. Their position is factory set for optimum performance on most ribbons. You can turn the red ring 180 degrees clockwise or counterclockwise to adjust the vertical position of the ribbon relative to the print head. Turning the ring 180 degrees changes the ribbon’s position by .014 inch.

Figure 5-1. Ribbon Adjustment Assembly

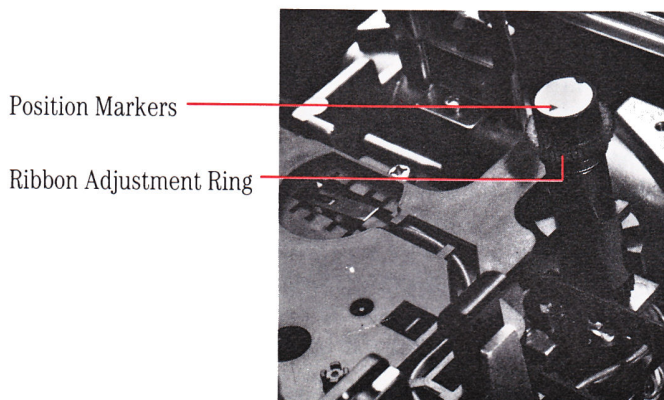

2. Push the red ring downward to free it. If color overlap appears at the bottom of characters, turn the ring clockwise as far as you deem necessary. Likewise, if color overlap appears toward the top of characters, turn the ring counterclockwise. Do not try to exceed 180 degrees in either direction; you could break the mechanism.
3. Release the ring when you have turned it to the desired position. The ring will pop up and lock into the new position.
4. Replace the ImageWriter II's cover.
5. Run the ImageWriter II self-test and study the areas you were having problem with. Another adjustment may be necessary.

The ImageWriter II Self-Test

The self-test only tests the printer, not its communications, cables, connectors, or the computer. Here's how to run the test.

1. Turn off the printer and wait for a few seconds.
2. Press the Form Feed button and hold it down while pressing the On/Off button. Release both buttons. Let the ImageWriter II print a half a page or so.
3. Turn off the printer to stop the test.
4. Study the printout. All characters should print clearly. If the problem you saw when printing from the computer appears in the test, the problem probably lies with the printer. Contact your authorized Apple dealer for assistance.

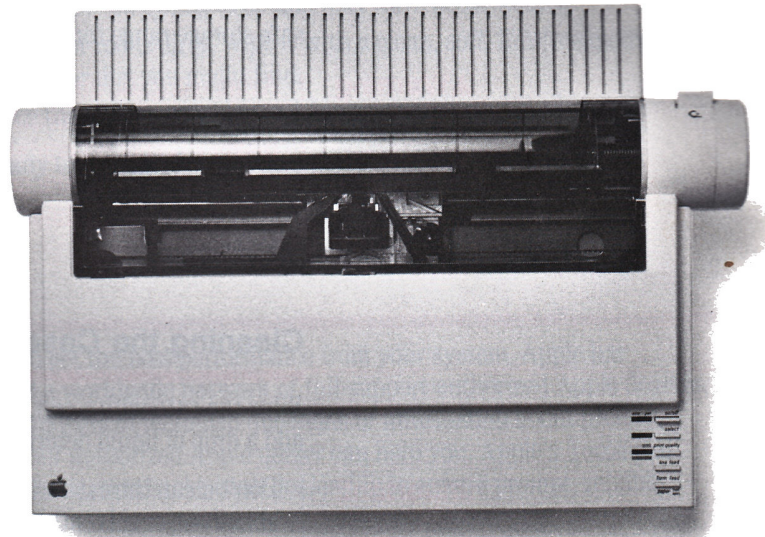

A good environment plus occasional cleaning will keep your ImageWriter II printer in top working condition for years to come.

Operating Environment

Apple designed the ImageWriter II to work well in any reasonably clean, indoor location. The ImageWriter II operates reliably in temperatures from 50° to 104° Fahrenheit (10° to 40° Celsius). You should not attempt to operate it outside of this range. The safe, non-condensing humidity range is from 20% to 95%. You can safely *store* the ImageWriter II in more extreme temperatures—from -40° to 116° Fahrenheit (-40° to 47° Celsius). The safe storage range for non-condensing humidity is 10% to 95%.

▲ Warning

Avoid using the ImageWriter II in a dusty environment or exposing the printer to chemical or solvent fumes (including steam from a coffee maker). Do not set containers filled with liquids—such as cups of coffee—on or near the printer. Do not leave the printer in direct sunlight for long periods of time.

Cleaning the Case

Wipe the case with a soft, damp (not *wet*) cloth. To remove stains or dirt, add a drop of liquid detergent to a damp cloth before wiping.

Important!

Don't clean the case with household cleansers, ammonia, powders, abrasives, or solvents (such as cleaning fluid). Any of these can mar the ImageWriter II's finish.

Cleaning the Inside of Your ImageWriter II

It's a good idea to clean the inside of your ImageWriter II once a month, mainly to remove paper dust and bits of paper. The ImageWriter II does not need lubrication thanks to special materials in the print mechanism.

To clean the inside of your ImageWriter II, you should have either a soft, clean brush or small can of compressed air. You could also use a clean, lint-free cloth. Here's how to do it:

1. Turn off the printer and remove the front cover.
2. Remove the ribbon cartridge by gently bending aside either of the support tabs and popping out the cartridge.
3. Brush or blow away any dust that may have accumulated.
4. If the carrier rod is dirty, wipe it with a clean, soft, lint-free cloth. Clean up any other dirt you might find.
5. Replace the ribbon cartridge and front cover.

You're ready to print again.

Service

To help you get the best performance from your system, Apple has established a worldwide network of full-support authorized Apple dealers. If you need answers to technical questions or information about product updates, your authorized Apple dealer can help you. Apple's Technical Support organization backs each dealership to ensure prompt, reliable assistance.

If service is required on your ImageWriter II, or on any Apple product, take it to your local authorized Apple dealer. If you have moved, take it to the nearest authorized Apple Service Center. There are more than 2100 authorized Apple dealers and Service Centers throughout the world. For the location nearest you, in the United States call (800) 538-9696; in Canada, (800) 268-7682.

Technical Support

If you have questions that your dealer is unable to answer, ask to be referred to Apple Technical Support. Apple Technical Support provides your dealer with Technical Notes (which answer commonly asked questions) and with access to technical support specialists.

Your dealer has the latest information on new hardware and software products and will keep you informed about any product updates. If you want to upgrade your system, your dealer can help you select compatible components.

AppleCare

Apple also offers the AppleCare® Service Agreement, which keeps your warranty in force for an additional year. AppleCare is one of the lowest-priced service packages in the industry, and your AppleCare agreement will be honored at all participating authorized Apple Service Centers within the country of purchase—an added benefit if you relocate. Local service means time saved in getting your Apple system back to work.

You may purchase AppleCare at any time, but for uninterrupted protection, it's a good idea to buy the service along with your system. In addition to providing you with complete coverage, purchasing AppleCare along with your system avoids an owner-paid dealer inspection of your system if your warranty has expired.

AppleCare is available through your authorized Apple dealer.

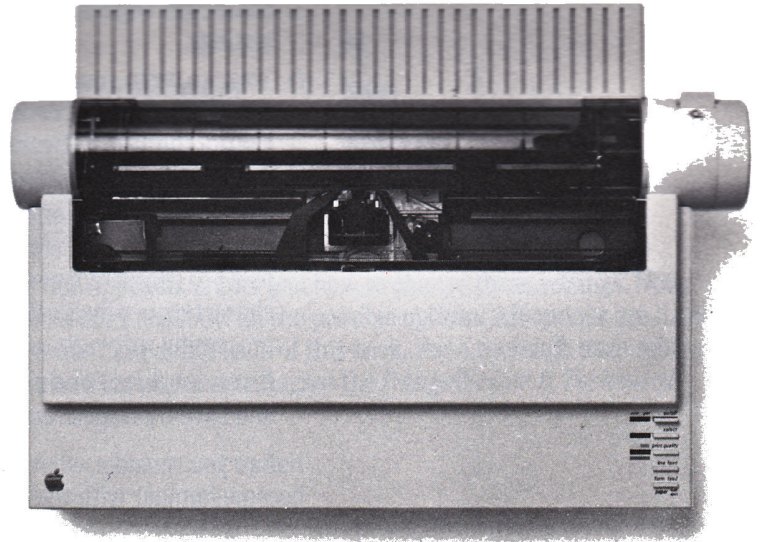

If you need to change printer output or do some **troubleshooting**, there are several ways to change ImageWriter II default settings. **But you may not** have to bother with changing the printer output by changing settings. Many people are satisfied with the printouts created using the **standard settings**. In addition, if you use a powerful application program such as **AppleWorks**, the software options cover most changes you might want to make. **And, if** you own a Macintosh Plus or a Macintosh, you can change a document's appearance on the screen through ruler settings and menu selections.

| *By the Way:* Software changes override switch settings.

Here are ways of changing default settings.

- Many application programs let you type in a **setup string**—a group of characters beginning with ESCAPE or CONTROL that change printer settings.
- You can write your own program in languages like BASIC or Pascal. Such a program becomes necessary when an application does not allow direct control through software or a setup string.
- You can reset ImageWriter II DIP switch settings. Once you flip a switch, the setting stays in effect when you turn the power off, unlike software-generated settings. For example, you might prefer to print in pica (10 characters per inch) most of the time, instead of elite (12 characters per inch). If you can't change this setting from your word processing software, you can reset the relevant switches.
- If you use AppleWorks, you can create your own printer modifications and save them as a "custom printer" setup. See Appendix F for details.

Before you consider what changes you might make, it's a good idea to become familiar with the standard settings.

Standard Settings for the ImageWriter II

Here is a partial list of standard settings for the ImageWriter II. These are the settings most often changed by average users. For a complete list, see Appendix C.

Maximum line width	8 inches
Left margin	0
Character set	American
Characters per inch	12
Lines per inch	6
Lines per page	66
Line feed after carriage return	None
Baud rate	9600 baud
Protocol	Hardware handshake
Horizontal tabs	Cleared

The rest of this appendix shows you how to change these settings. Note: This appendix does not show all the possible options. All options are listed on the reference card at the back of this book. For a thorough discussion of your printer and its output options, see the *ImageWriter II Technical Reference Manual*.

Changing Settings With DIP Switches

The ImageWriter II has two DIP (dual inline package) switch blocks, designated SW1 and SW2. Both are located toward the lower left corner of the printer. (You may have to slide the ribbon deck to the right in order to see them.) See Figure A-1.

Figure A-1. Location of DIP Switches

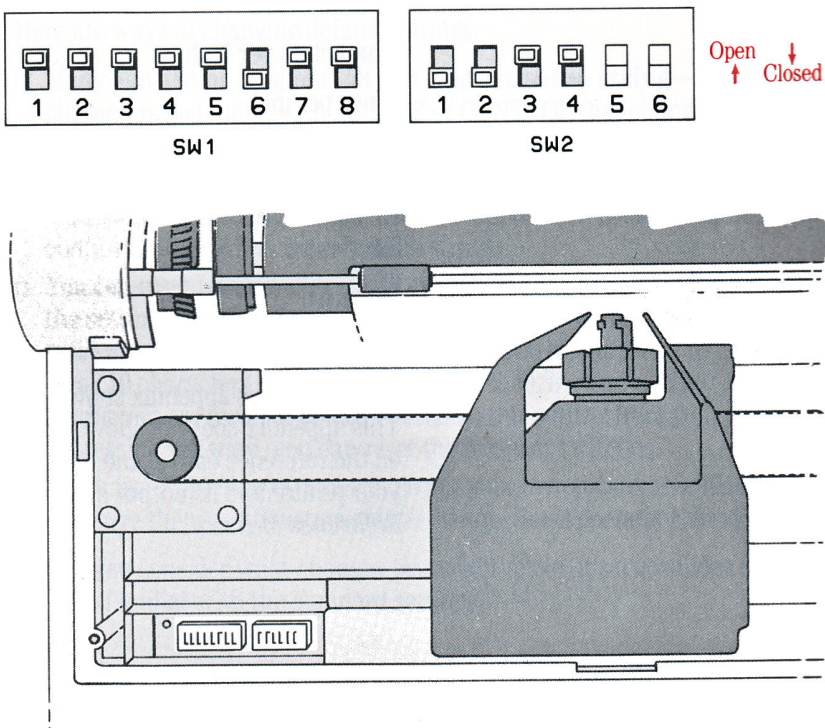

SW1 has eight switches and SW2 six switches (two of which shouldn't be touched: SW2-5 and SW2-6). Tables A-1 and A-2 show the default settings for each block and describe the functions of the switches. If you are reading this section to help with troubleshooting, compare the actual switch settings with those shown in Figure A-1.

▲Warning

Do not touch switches SW2-5 and SW2-6. These are reserved for authorized Apple technicians to adjust hammer-fire timing.

Table A-1. Default Settings for SW1

Note: Some DIP switches use Off for Open and On for Closed.

Switch	Setting	Concern	Default
1	Open	Character set	American
2	Open	Character set	American
3	Open	Character set	American
4	Open	Page length	66 lines
5	Open	Skip perforation	No
6	Closed	Chars per inch	Elite (12 cpi)
7	Open	Chars per inch	Elite (12 cpi)
8	Open	LF after CR	None

Table A-2. Default Settings for SW2

Note: SW2-5 and SW2-6 are factory set. Do not change their settings.

Switch	Setting	Concern	Default
1	Closed	Baud rate	9600
2	Closed	Baud rate	9600
3	Open	Comm protocol	DTR (handshake)
4	Open	Option card	No card

Important!

If you have the 32K Memory Option or AppleTalk card, SW2-4 should be Closed. If you have installed an Apple Communications Card or other interface card that transmits at 300 baud, switches SW2-1 and SW2-2 should both be Open.

To explore the other available DIP switch options, see Appendix C.

Using Control Characters and Escape Sequences

You can change various settings on the ImageWriter II by sending the printer either a **control character** or an **escape sequence**. Essentially, both of these send instructions to the printer; for example, change to bold type, issue a form feed, and return to normal type, are all instructions to the printer. A control character is just a single character, whereas an escape sequence always begins with an escape character and is followed by one or more characters.

With members of the Apple II family, you can communicate these instructions to the printer by pressing certain keys (after a PR#1 or as a setup string) or by writing commands into a program. For example, typing **CONTROL-L** as a setup string sends a single character instruction telling the printer to perform a form feed.

Note: Beyond their command menus, the Macintosh Plus, Macintosh, Macintosh XL, and the Lisa Office System can command the printer through programs, but not through typing a direct command.

If you wanted to write a program to send a form feed instruction to the printer, you would write a line using the control character's ASCII code. (The form feed character's ASCII code is 12.) For example, an Applesoft program might have the line

```
40 PRINT CHR$(12)
```

ASCII Codes

ASCII stands for the *American Standard Code for Information Interchange*. This code is a standard character set used by many computers and peripheral devices to process and communicate data. Appendix B has a complete list of all ASCII codes.

You can also type escape sequence characters directly to the printer (in an application program or after a PR#1 instruction). For example, to have the ImageWriter II print in boldface type, you would press

ESC !

In a program, you would need to supply the ASCII codes for ESCAPE (27) and for ! (33). As an alternative, you could enclose the exclamation point in double quotation marks—"!". Thus, your program line would look like this

```
50 PRINT CHR$(27); CHR$(33)
```

or this

```
50 PRINT CHR$(27); "!"
```

Commonly Used Printer Instructions

This section gives the most commonly used control codes and escape sequences. For other codes, see the reference card at the back of this manual and the *ImageWriter II Technical Reference Manual*. A sample configuration program follows these instructions.

By the Way: If you have an application program that you need to configure for printing, pay close attention to the following codes. Configuration programs often prompt you for information such as the code for boldface type, for underlining, and so on.

When typing control sequences directly, do not include the spaces between the symbols or the hyphens that separate the word CONTROL from the control character. ESCAPE means press the **ESC** key and then release it. CONTROL means press the **CONTROL** key and hold it down while pressing the character key.

Before starting, keep two things in mind. First, uppercase and lowercase are meaningful when writing Escape sequences. That is, ESCAPE-N and ESCAPE-n are two *different* instructions. If your Apple computer cannot generate lowercase characters, you'll need to write your instructions with ASCII characters.

On the other hand, the case of characters makes no difference when writing Control codes. CONTROL-n and CONTROL-N send the same instruction.

Table A-3. Turning Special Features On and Off

Feature	On	On (ASCII)	Off	Off (ASCII)
Boldface	ESCAPE !	27 33	ESCAPE "	27 34
Underlining	ESCAPE X	27 88	ESCAPE Y	27 89
Superscripts	ESCAPE x	27 120	ESCAPE z	27 122
Subscripts	ESCAPE y	27 121	ESCAPE z	27 122
Half-height characters *	ESCAPE w	27 119	ESCAPE W	27 87
Slashed zeros	ESCAPE D	27 68	ESCAPE Z	27 90
	CONTROL-@	0 1	CONTROL-@	0 1
	CONTROL-A		CONTROL-A	

* Half-height characters look best when printed in conjunction with 17 cpi.

Table A-4. Selecting Special Features

Feature	Access	ASCII Equivalent	
Character Size			
Extended (9 cpi)	ESCAPE n	27	110
Pica (10 cpi)	ESCAPE N	27	78
Elite (12 cpi)	ESCAPE E	27	69
Semicondensed (13.4 cpi)	ESCAPE e	27	101
Condensed (15 cpi)	ESCAPE q	27	113
Ultracondensed (17 cpi)	ESCAPE Q	27	81
Proportional Spacing			
Proportional Pica	ESCAPE p	27	112
Proportional Elite	ESCAPE P	27	80
Lines per Inch			
6 Lines per Inch	ESCAPE A	27	65
8 Lines per Inch	ESCAPE B	27	66
Print Quality*			
Draft	ESCAPE a 1	27	97 49
Standard	ESCAPE a 0	27	97 48
Near Letter Quality	ESCAPE a 2	27	97 50

*These codes override the control cluster button setting.

Table A-5. Selecting Language Fonts

Language	Access	ASCII Equivalent
American	ESCAPE Z CONTROL-G CONTROL-@	27 90 7 0
British	ESCAPE Z CONTROL-D CONTROL-@ ESCAPE D CONTROL-C CONTROL-@	27 90 4 0 27 68 3 0
German	ESCAPE Z CONTROL-C CONTROL-@ ESCAPE D CONTROL-D CONTROL-@	27 90 3 0 27 68 4 0
French	ESCAPE Z CONTROL-A CONTROL-@ ESCAPE D CONTROL-F CONTROL-@	27 90 1 0 68 6 0
Swedish	ESCAPE Z CONTROL-B CONTROL-@ ESCAPE D CONTROL-E CONTROL-@	27 90 2 0 27 68 5 0
Italian	ESCAPE Z CONTROL-F CONTROL-@ ESCAPE D CONTROL-A CONTROL-@	27 90 6 0 27 68 1 0
Spanish	ESCAPE D CONTROL-G CONTROL-@	27 68 7 0
Danish	ESCAPE Z CONTROL-E CONTROL-@ ESCAPE D CONTROL-B CONTROL-@	27 90 5 0 27 68 2 0

Table A-6. Alternate Language Fonts

American	#	\$	@	[\]	^	`	()	~
British	£	\$	@	[\]	^	`	()	~
German	#	\$	§	Ä	Ü	U	^	`	ä	ö	ü	ß
French	£	\$	à	•	ç	§	^	`	é	ù	è	¨
Swedish	#	\$	@	Ä	Ü	Å	^	`	ä	ö	å	~
Italian	£	\$	§	•	ç	é	^	ù	à	ò	è	ì
Spanish	£	\$	§	;	Ñ	¿	^	`	•	ñ	ç	~
Danish	#	\$	@	Æ	Ø	Å	^	`	æ	ø	å	~
Decimal	35	36	64	91	92	93	94	96	123	124	125	126
Hexadecimal	\$23	\$24	\$40	\$5B	\$5C	\$5D	\$5E	\$60	\$7B	\$7C	\$7D	\$7E

By the Way: To type a Spanish hyphen, press the single quotation mark key.

Selecting Color

The color options work only when you have installed a **color ribbon**. The color option instruction is

```
ESCAPE K n
27      75 d
```

Here, the letter *n* represents a color number you must enter and *d* is the ASCII equivalent:

	Access	ASCII
Black	0	48
Yellow	1	49
Red	2	50
Blue	3	51
Orange	4	52
Green	5	53
Purple	6	54

Setting Left Margin

```
ESCAPE L nnn
27      76
```

nnn stands for any three-digit number. For example, if you were to type `[ESC] L 035`, the printer would begin printing in the 36th character position, calculated from the zero position (not first position) marked by the left red ring on the paper bail.

Pushing a Page to Top of Form

```
ESCAPE v
27      118
```

A Sample BASIC Program

Figure A-2 is a program written in Applesoft BASIC. The program gives a brief demonstration of how to turn various printer commands off and on and ends with a form feed to eject the printed page.

Figure A-2. Listing for Applesoft Printer Control Program

```
10 REM DEMO PRINTER CONTROLS
20 PRINT CHR$(4); "PR#1": REM SEND TO PRINTER
30 LET ESC$ = CHR$(27): REM SAVE SOME KEYSTROKES
40 PRINT "THIS IS THE DEFAULT FONT"
50 PRINT ESC$; CHR$(33): REM BOLD ON
60 PRINT "THIS IS BOLDFACE"
70 PRINT ESC$; "X": REM UNDERLINE ON
80 PRINT "AND THIS IS UNDERLINED BOLD"
90 PRINT ESC$; CHR$(34): REM BOLD OFF
100 PRINT "AND THIS IS UNDERLINE ONLY"
110 PRINT ESC$; "Y": REM UNDERLINE OFF
120 PRINT "BACK TO DEFAULT"
130 PRINT ESC$; CHR$(81): REM ULTRACONDENSED
140 PRINT "NO BOLD, NO UNDERLINE FOR AN ULTRACONDENSED FINISHED"
150 PRINT "OKAY, PUSH THE PAPER"
160 PRINT CHR$(12): REM FORM FEED
170 PRINT ESC$; "E": REM ELITE TYPE ON
180 PRINT CHR$(4); "PR#0": REM BACK TO SCREEN
```

For more details on settings, see Appendixes C and E, the reference card at the end of the book, and the *ImageWriter II Technical Reference Manual*.

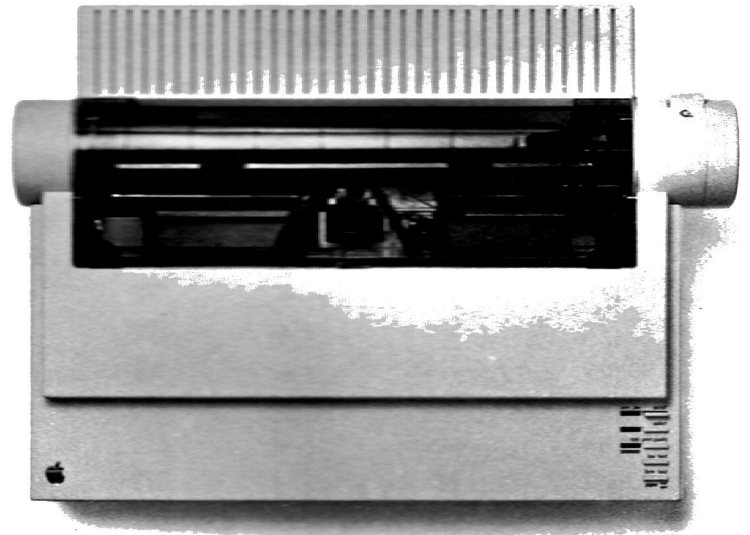

Table B-1. ASCII Codes for Normal Characters

ASCII Code	Char	ASCII Code	Char	ASCII Code	Char	ASCII Code	Char
0	NULL	32	SPACE	64	@	96	`
1	SOH	33	!	65	A	97	a
2	STX	34	"	66	B	98	b
3	ETX	35	#	67	C	99	c
4	EOT	36	\$	68	D	100	d
5	ENQ	37	%	69	E	101	e
6	ACK	38	&	70	F	102	f
7	BELL	39	'	71	G	103	g
8	BS	40	(72	H	104	h
9	HT	41)	73	I	105	i
10	LF	42	*	74	J	106	j
11	VT	43	+	75	K	107	k
12	FF	44	,	76	L	108	l
13	CR	45	-	77	M	109	m
14	SO	46	.	78	N	110	n
15	SI	47	/	79	O	111	o
16	DLE	48	0	80	P	112	p
17	DC1 (XON)	49	1	81	Q	113	q
18	DC2	50	2	82	R	114	r
19	DC3 (XOFF)	51	3	83	S	115	s
20	DC4	52	4	84	T	116	t
21	NAK	53	5	85	U	117	u
22	SYN	54	6	86	V	118	v
23	ETB	55	7	87	W	119	w
24	CAN	56	8	88	X	120	x
25	EM	57	9	89	Y	121	y
26	SUB	58	:	90	Z	122	z
27	ESC	59	;	91	[123	{
28	FS	60	<	92	\	124	
29	GS	61	=	93]	125	}
30	RS	62	>	94	^	126	~
31	US	63	?	95	_	127	DEL

Table B-2. ASCII Codes for Inverse Characters

ASCII Code	Char	ASCII Code	Char	ASCII Code	Mouse Text	ASCII Code	Char
128	@	160	SPACE	192	🍏	224	`
129	A	161	!	193	🍎	225	a
130	B	162	"	194	▶	226	b
131	C	163	#	195	✂	227	c
132	D	164	\$	196	↙	228	d
133	E	165	%	197	✉	229	e
134	F	166	&	198	↶	230	f
135	G	167	'	199	≡	231	g
136	H	168	(200	↑	232	h
137	I	169)	201		233	i
138	J	170	*	202	↶	234	j
139	K	171	+	203	↷	235	k
140	L	172	,	204		236	l
141	M	173	-	205	↶	237	m
142	N	174	.	206	■	238	n
143	O	175	/	207	↶	239	o
144	P	176	0	208	↶	240	p
145	Q	177	1	209	↶	241	q
146	R	178	2	210	↶	242	r
147	S	179	3	211		243	s
148	T	180	4	212	└	244	t
149	U	181	5	213	→	245	u
150	V	182	6	214	▣	246	v
151	W	183	7	215	▣	247	w
152	X	184	8	216	U	248	x
153	Y	185	9	217	U	249	y
154	Z	186	:	218	—	250	z
155	[187	;	219	◆	251	{
156	\	188	<	220		252	
157]	189	=	221	≠	253	}
158	^	190	>	222	□	254	~
159	_	191	?	223	□	255	Blot

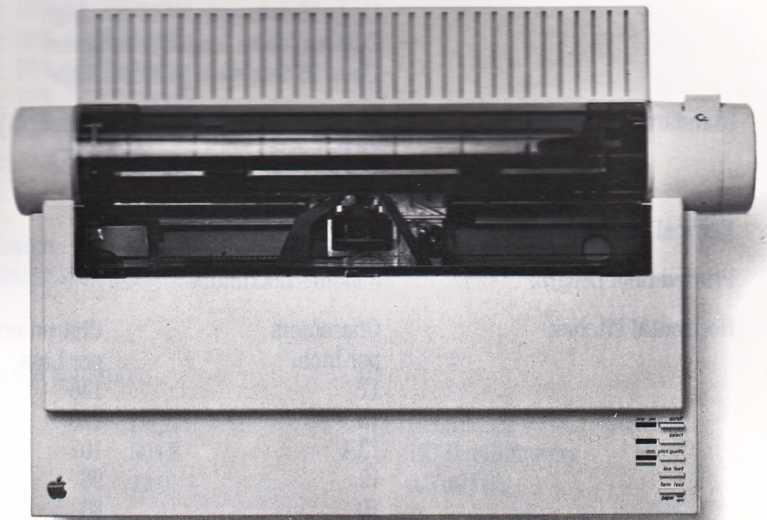

Table C-1. Printer Specifications

Print Method:	Dot matrix, logic seek (line by line)		
Printing Speed:	Draft max	250 cps @ 10 cpi	
	Correspondence max	180 cps @ 10 cpi	
	NLQ max	45 cps @ 10 cpi	
Character Format:	Standard characters		
	Up to 7 dots wide by 8 dots high		
	Draft characters		
	Up to 12 dots wide by 8 dots high		
	NLQ characters		
	Up to 16 dots wide by 16 dots high		
Standard Characters:	Custom (down loaded) characters		
	Up to 16 dots wide by 8 dots high		
	96 ASCII (alphanumeric and symbols)		
	28 European language characters		
Vertical Dot Spacing:	32 MouseText characters		
	1/72 of an inch		
Printed Line Length:	8 inches maximum		
Horizontal Pitches:	Characters	Characters	Dots
	per Inch	per Line	per Inch (Approx.)
	17	136	136
	15	120	120
	13.4	107	107
	12	96	96
	10	80	80
	9	72	72
	Proportional-1	variable	160
	Proportional-2	variable	144
Paper Feed Direction:	Forward and reverse		
Line Spacing:	1/144 to 99/144 of an inch, selectable in increments of 1/144 of an inch		
Line Feed Speed:	Max. 24 lps @ 6 lpi		
Paper Width:	3.5 to 9.5 inches pin to pin (pin feed), 10 inches maximum		
Paper Thickness:	0.05 - 0.28 millimeter		
	(0.002 - 0.011 inch)		
	Original + 3 copies maximum		
Paper Feed Method:	Selectable, friction or friction/pin-feed		

Table C-1—Continued. Printer Specifications

Paper Types:	Single sheets Pin-feed paper (hole centers 4.0 - 9.5 inches)		
Ribbon:	Cassette containing black inked fabric ribbon 13 mm wide by 13000 mm long, continuous Four color ribbon optional 21 mm wide by 18000 mm long, continuous		
Power Options:			
American	120 volts AC \pm 10%, 60 hertz		
Universal	100 volts AC \pm 10%, 50/60 hertz 120 volts AC \pm 10%, 50/60 hertz 140 volts AC \pm 10%, 50/60 hertz 200 volts AC \pm 10%, 50/60 hertz 220 volts AC \pm 10%, 50/60 hertz 240 volts AC \pm 10%, 50/60 hertz		
Power Consumption:			
Operating	180 watts maximum		
Standby	20 watts maximum		
Data Interface:	8-bit serial		
Weight:	11.36 kilograms (25 pounds)		
Dimensions:	Width	Depth	Height
	431.8	304.8	127.0 millimeters
	17.0	12.0	5.0 inches
Ambient Temperature:			
Operating	10 to 40 degrees Celsius (50 to 104 degrees F.)		
Storage	-40 to +47 degrees Celsius (-40 to +116 degrees F.)		
Humidity:			
Operating	20% to 95% relative humidity, noncondensing		
Storage	10% to 95% relative humidity, noncondensing		

Table C-2. ImageWriter II DIP Switch Settings

	SW1-1	SW1-2	SW1-3
American	Open	Open	Open
Italian	Closed	Open	Open
Danish	Open	Closed	Open
British	Closed	Closed	Open
German	Open	Open	Closed
Swedish	Closed	Open	Closed
French	Open	Closed	Closed
Spanish	Closed	Closed	Closed
	SW1-4		
Form length 11 inches	Open		
Form length 12 inches	Closed		
	SW1-5		
Perforation skip inactive	Open		
Perforation skip active	Closed		
	SW1-6	SW1-7	
10 cpi	Open	Open	
12 cpi	Closed	Open	
17 cpi	Open	Closed	
160 dpi (proportional)	Closed	Closed	
	SW1-8		
Carriage return only	Open		
Carriage return plus line feed	Closed		

Table C-2—Continued. ImageWriter II DIP Switch Settings

	SW2-1	SW2-2
300 Baud	Open	Open
1200	Closed	Open
2400	Open	Closed
9600	Closed	Closed
	SW2-3	
Hardware Handshake Protocol	Open	
XON/XOFF Protocol	Closed	
	SW2-4	
Option disabled (No option card)	Open	
Option Enabled	Closed	

▲Warning | Do not adjust DIP switches SW2-5 and SW2-6. They are factory-set to control hammer-fire timing.

Table C-3. Interface Specifications

Data Input Form:	8-bit asynchronous serial: 1 start bit, 8 data bits, 1 stop bit (no parity)
Data Input Codes:	Characters: ASCII, 8- or 7-bit Graphics: 8-bit binary
Transmission Speed:	300, 1200, 2400, or 9600 baud
Input Buffer Size:	2K bytes, 32K bytes w/ 32K Memory Option
Printer Connector:	Mini-circular connector, 8-pin socket or equivalent
Cable Connector:	Mini-circular connector, 8-pin plug or equivalent

Table C-4. Pin Connections

Pin No.	Symbol	Description	Direction
1	DTR	Data Terminal Ready	Output
2	DSR	Data Set Ready	Input
3	TxD-	Transmit Data -	Output
4	SG	Signal Ground	
5	RxD-	Receive Data -	Input
6	TxD+	Balanced Transmit +	Output
7	NC	No Connection	
8	RxD+	Balanced Receive +	Input
Shield	PG	Protective Ground	

Figure C-1. 8-Pin Mini-Circular Connector Pinouts

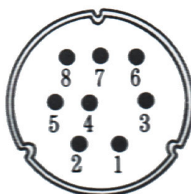
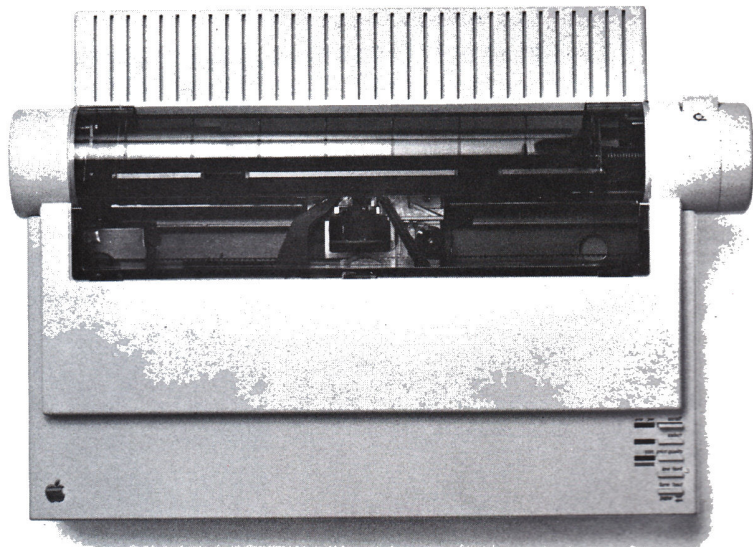

Table C-5. Cable Connections

Mini-Circular Connector (RS 422/423)	DB25-P (RS232-C)	Symbol
1	6*	DSR
1	8*	DCD
2	20	DTR
3	3	RXD
4**	7	GND
5	2	TXD
6	—	NC
7	—	NC
8**	—	GND
Shield		Shield

*Jumpered together at DB25

**Jumpered together at Mini-Circular Connector



This appendix shows you how to connect the ImageWriter II to the Macintosh XL, the Lisa Office System, and the Apple III. Appendix D assumes that you have installed the ribbon and loaded the appropriate paper into the printer. You should also have successfully self-tested the ImageWriter II. If you have not completed these activities, see Chapter 2, “Basic ImageWriter II Setup.”

All three computers take the same serial interface cable, the Apple IIe Modem-8 Cable, Apple Part Number A2C0311. Check to make sure you have the correct cable. (See Figure D-1.)

Figure D-1. Apple IIe Modem-8 Cable

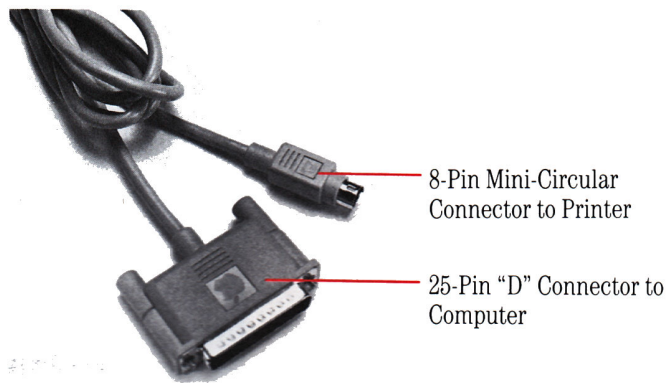

▲Warning

If your cable does not have the proper connectors at its ends, don't try to make it fit; see your authorized Apple dealer before continuing.

Important!

Your Apple computer and its peripheral devices are FCC-certified under test conditions that include use of **shielded cables** and connectors between system components. It is important that you use shielded cables and connectors to reduce the possibility of causing interference to **radio**, television, and other electronic devices.

A **shielded cable** is a cable that uses a metallic wrap around the wires to reduce the potential effects of radio frequency interference.

Regardless of which computer you're connecting to, you can follow a few preliminary steps. Before beginning, make sure that your computer and printer are turned off.

▲Warning

Make sure you have turned off both the computer and a peripheral device, such as a printer, before connecting or disconnecting them. Connecting or disconnecting cables when the power is on can damage your equipment.

Connecting the Printer Cable to the ImageWriter II

Begin by plugging the cable into the ImageWriter II. Locate the 8-pin, mini-circular connector (shown in Figure D-2) on your printer cable. Notice the little apple in the top of the connector. The apple side is the top side of the connector.

Figure D-2. The 8-Pin Mini-Circular Connector



Plug the connector into the **ImageWriter II's** serial interface socket. (See Figure D-3.) Make sure you **get a firm fit**. **Loose connections** can cause interference with radios and televisions, **scramble data**, or stop the printing process.

Figure D-3. Plugging the Printer Cable Into the Printer

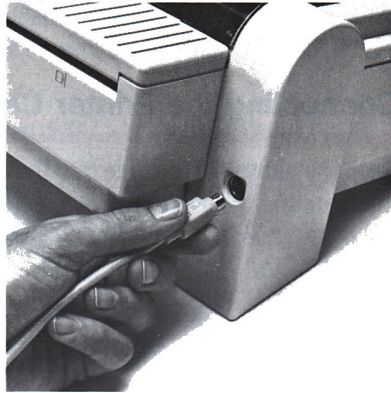

Now you can connect the cable to your computer.

Connecting to the Macintosh XL

To connect the ImageWriter II to your Macintosh XL, follow these steps.

1. Plug the cable connector into the Macintosh XL Serial B printer port (see Figure D-4), unless this port is already in use. If you have another cable plugged into the Serial B port (such as AppleTalk), connect to the Serial A modem port. Tighten the thumbscrews to seat the connector firmly in its socket.

Figure D-4. Plugging the Printer Cable Into the Serial B Port

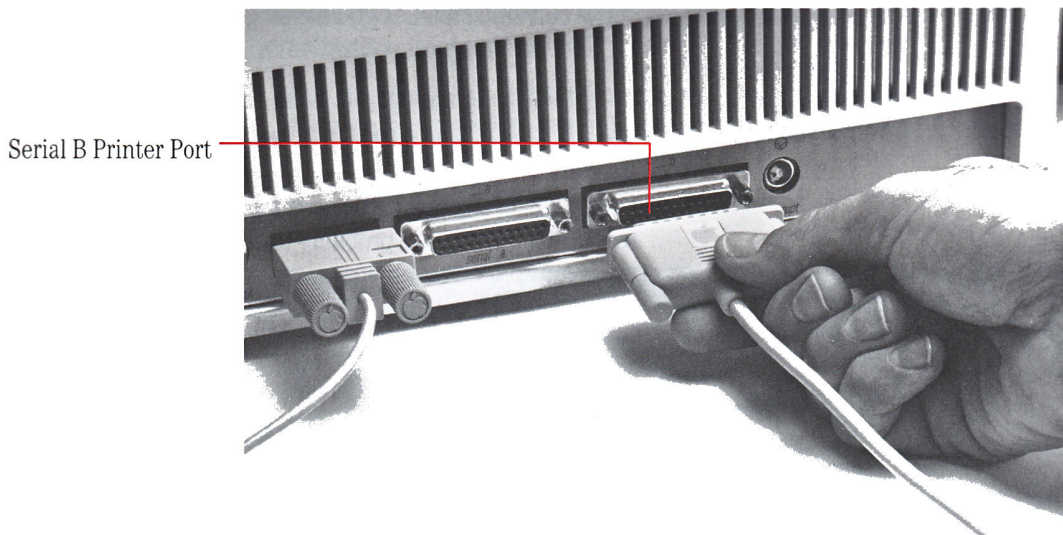

2. Start your Macintosh XL with MacWorks™. (You must be in MacWorks to install the printer.)
3. Turn the printer on and make sure that its Select light is on.
4. Pull down the  menu. If you see the Choose Printer accessory, connect or disconnect AppleTalk as appropriate. Then select the device and/or port icon that matches your system.

If you see the Chooser accessory, first open the Control Panel to connect or disconnect AppleTalk. Then select the Chooser to set the appropriate device and/or port icon. If you need help with these procedures, see your owner's guide for details.

By the Way: After making printer software choices, you may want to look at the Page Setup in the File menu to check the printer's name and other settings.

5. To test the ImageWriter connection, press the **CAPS LOCK** key into its down position. Then hold down  and **SHIFT** while you press **4** from the main keyboard (*not* the numeric keypad). Your ImageWriter II should begin printing the contents of the current Macintosh XL screen.

If it does not, see the next section, "Solving Printer Software Problems" and, if necessary, Chapter 5, "General Troubleshooting."

Important!

The test may split your screen between two pages. This is OK. The important thing is that the printer prints an accurate representation of the current screen. If you do not get a screen image, see Chapter 5, “General Troubleshooting.”

Solving Printer Software Problems

If all your connections are correct and the printer is on and selected, but the test doesn't print, you probably have a software problem. Check these two areas for problems:

First, Pull down the  menu. If you see the Choose Printer accessory, make sure you have selected the correct AppleTalk status (Connected or Disconnected), device, and port.

If you see the Chooser accessory, first open the Control Panel to see if AppleTalk is Connected or Disconnected. Then select the Chooser and make sure you have selected the correct device and port icons.



Second, see if you have a recent ImageWriter II printer resource; open the System Folder. If the ImageWriter II icon looks like either of the ones shown in the margin, you're ready to print. If you have a different ImageWriter II icon or no ImageWriter II icon at all, see your authorized Apple dealer for a software update.

Important

If you still can't get the test to work and have the Chooser accessory in your  menu, you should run the Installer program again. Never try to install Chooser and the software that goes with it by dragging icons or running Font D/A Mover.

By the Way: You may also want to check the **Control Panel** and make sure the settings are the way you want them.

Connecting to the Lisa Office System

Connecting the Lisa takes two steps: plugging in the cable and setting a Preference.

1. Plug the remaining end of the cable into Lisa's printer Port B. (See Figure D-5.) Tighten the thumbscrews on the connector for a firm fit.

Figure D-5. Connecting to Serial B Port

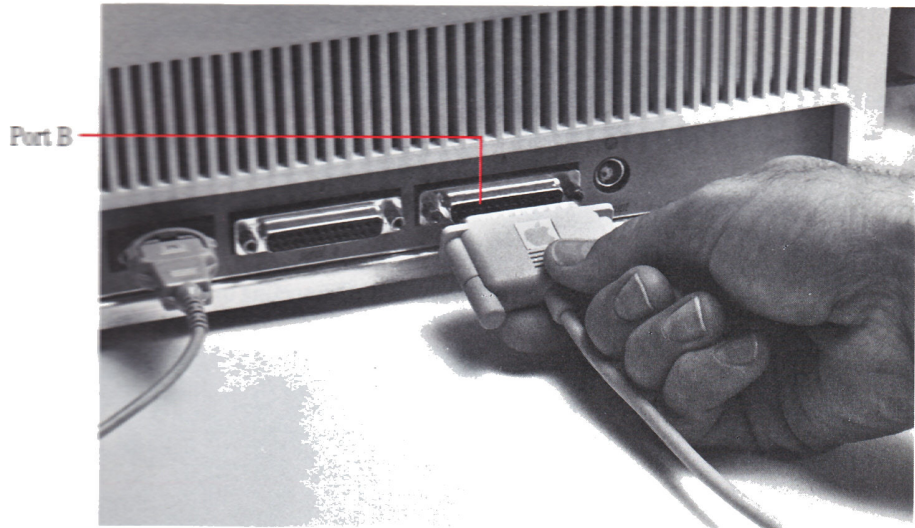

Important!

The Lisa reserves the Serial A port for modem communications and the Serial B port for printers. Be sure you have connected the ImageWriter II to the correct port.

2. Turn the Lisa on and open the **Preferences** icon.
3. Check **Connect Devices**.
4. Select **Serial B Connector**.
5. Check **ImageWriter II** (or just **Imagewriter**) on the list of available devices.
6. Finally, choose **Set Aside Preferences** from the File/Print menu.

With the connection made, you're ready to test your work.

Testing the Connection

Follow these steps to test your **connection and configuration**.

1. Turn the ImageWriter II on and make **sure the Select light** is on.
2. Hold down **OPTION** and press the **right SHIFT-4** (from the keypad) to print the current Lisa screen.

If the ImageWriter II produces an unacceptable **printout**, see **Chapter 5**, “General Troubleshooting.”

Connecting to the Apple III

Plug the connector into the Apple III's Port C. (See Figure D-6.) The Apple III doesn't have screw holes around Port C, so make sure the connector's thumbscrews don't interfere with a firm connection.

Figure D-6. Connecting to Port C

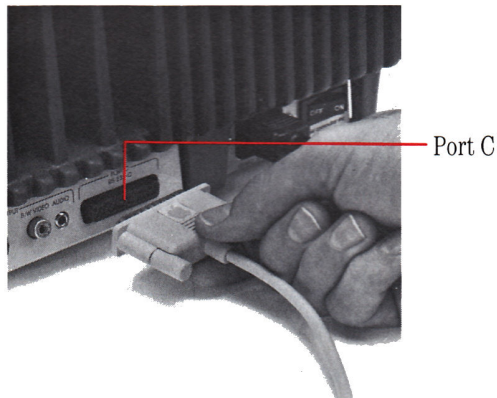

Configuring the Apple III

To configure the Apple III, you'll need the disk *System Utilities* and your application startup disk. Your *Apple III Standard Device Drivers Manual* describes this program. To configure your software, follow these steps.

1. Start your Apple III with *System Utilities*.
2. Put the application disk in drive 2.
3. From *System Utilities*, read in the `SOS.DRIVER` file and look for a driver named `.SERPRINTER`, `.PRINTER`, or `.QUME`. If you can't find a suitable driver on your startup disk, check your *System Utilities* disk for a file named `SERPRINTER.DRIVER` or `PRINTER.DRIVER`.
4. With the **Edit Driver Configuration** option, make sure that you've chosen a character driver working through the built-in serial interface port. (It will have the notation `n/a` following the label **Slot No.** on the **Edit Driver Parameters** screen.)
5. Edit the configuration block according to Table D-1 (based on `SERPRINTER.DRIVER`).

Table D-1. Printer Driver Configuration Block Settings

Byte	Value	Parameter	Setting
0	\$0E	Speed	9600 baud
1	\$00	Format	8 bits, no parity
2	\$00	CR Delay	None
3	\$00	LF Delay	None
4	\$00	FF Delay	None

Important!

Be sure to set baud rate to 9600, format to 8 bits, no parity, and set all delays to 0.

6. Generate a new system on each of your application startup disks.
7. To test your connection and configuration, start up the application you've changed and print something. If it works, you have a successful connection. If there is a problem with the printout, see Chapter 5, "General Troubleshooting."

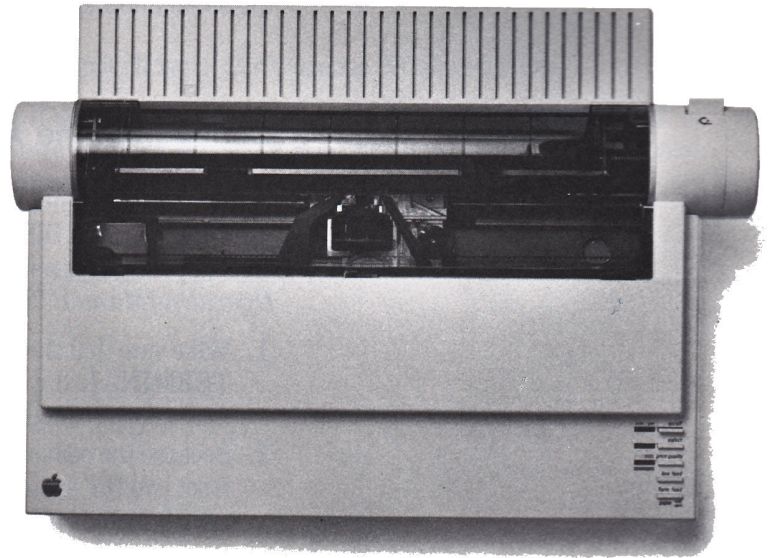

This appendix shows you how to **configure the Apple Serial Interface Card and Apple Serial Communications Card for use with the ImageWriter II**. It also gives tips on installing cards **not manufactured by Apple Computer, Inc.** This appendix assumes you have **followed the instructions** for opening your computer and removing your serial card given in **Chapter 3**.

▲Warning

Never open your computer, handle its circuitry, or install an interface card, unless you have turned off the computer's power switch. This is important; you could damage your computer and interface cards by working inside the computer while the power is on.

When you have configured your serial card, see "Installing and Connecting the Serial Interface Card" in Chapter 3.

Configuring the Apple Serial Communications Card

Configuring the communications card takes two steps: setting the jumper block and setting a DIP switch on the ImageWriter II. You may want to consult your *Communications Interface Card Installation and Operating Manual* for help.

1. Make sure that the triangle-shaped mark on the jumper block points to **TERMINAL**. If it does not, gently unplug the block from the card, rotate it accordingly, and plug it back into the card.
2. Because the communications card transmits data at 300 baud, you must reset two DIP switches in the ImageWriter II. Switches SW2-1 and SW2-2 should both be in the Open position. See Appendix A for details.

Configuring Other Serial Cards

Here is a list of ImageWriter II settings. Check your serial card manual for the appropriate switch settings.

- Baud rate: 9600
- Data format: 8 data bits, 1 stop bit, 1 start bit
- Parity: None
- Line feed after carriage return: Off
- Interrupts: Off
- Delays: None
- Operation mode: TERMINAL (*not* MODEM)

Baud Rate

If you have a card that cannot transmit data at 9600 baud, you must reset a switch in the printer itself to change the printer's baud rate. See Appendix A for details.

Apple II Serial Card Notes

If you have an Apple II Serial Card, note that the **ImageWriter II** requires *no delays* set for

- Carriage returns
- Line feeds
- Form feeds

| **Note:** For the Apple II Serial Card, Open is Off, Closed is On.

If your Apple II Serial Card has a ROM labeled P8A, you can send data at 9600 baud. However, if you have a P8 ROM, you must send data at 300 baud. Do not connect a modem eliminator cable to the Apple II Serial Card.

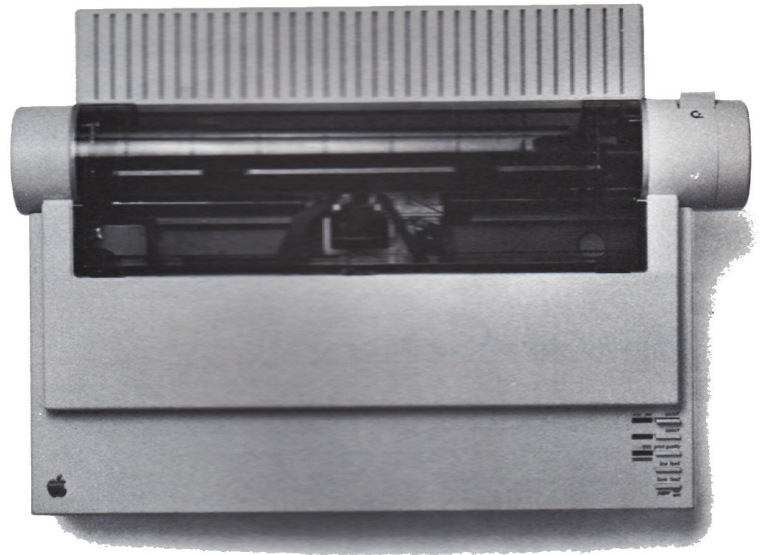

AppleWorks versions through 1.2 print full-height subscripts and superscripts. However, the ImageWriter II can print these text elements half-height. This appendix shows you how to create an AppleWorks printer driver that takes advantage of these half-height characters. Note that by configuring a custom printer to take advantage of half-height characters, you are giving up other capabilities, such as proportional spacing.

Important!

The new printer driver is an AppleWorks *Custom Printer*. You can have only one such custom printer on your AppleWorks program disk at a time. If you want to keep more than one custom printer, you must make a copy of the program disk to hold each custom printer. Further, you can have only three printer drivers on a single disk.

Follow these steps.

1. With the AppleWorks Main Menu on your screen, choose option 5, Other Activities Menu.
2. Choose option 7, Specify information about your printer(s)
3. From the Printer Information menu, choose option 2, Add a printer.

Figure F-1. Add a Printer Display

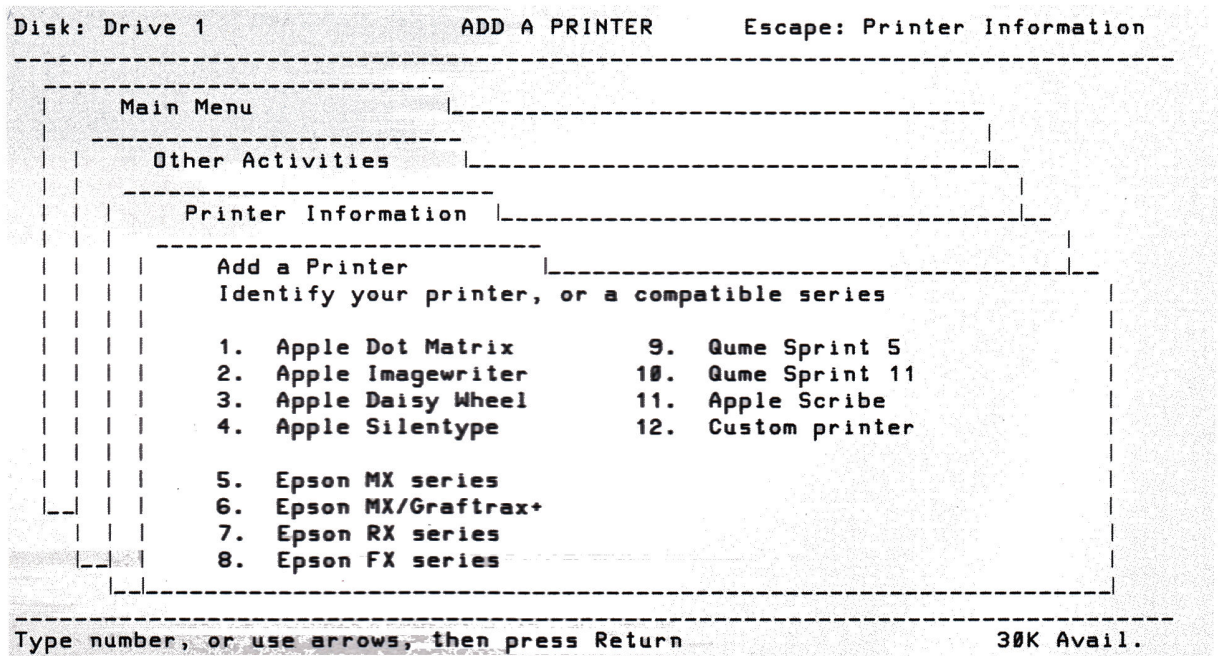

Too Many Printers? If you have three printers on your program disk, select the Remove command and remove one printer (not the ImageWriter II) and then add your new printer.

4. From the Add a Printer menu, choose option 12, Custom printer. (See Figure F-1.)
5. Respond to the request for a name by typing SuperSub (or whatever name you prefer) and press **RETURN**.
6. Unless you have your printer interface card in a slot other than slot 1, choose Port 1 for access.
7. Follow the prompts at the bottom of the screen to answer the questions on the Add a Printer menu:
 - No to Line feed.
 - Yes to top-of-page.
 - No to stop at the end of each page, unless you're using single sheets.
 - Yes to an eight-inch platen width.
 - Highlight the Printer codes option and press **RETURN**. This brings up the Printer codes menu.

- Choose option 3, **Boldface, Subscript and Superscript** and the Enhancements menu appears. (See Figure F-2.)

Correcting Typing Mistakes: If you find yourself entering a code incorrectly, press to return to the Enhancements menu and retype the escape sequence.

Figure F-2. The Printer Codes Menu

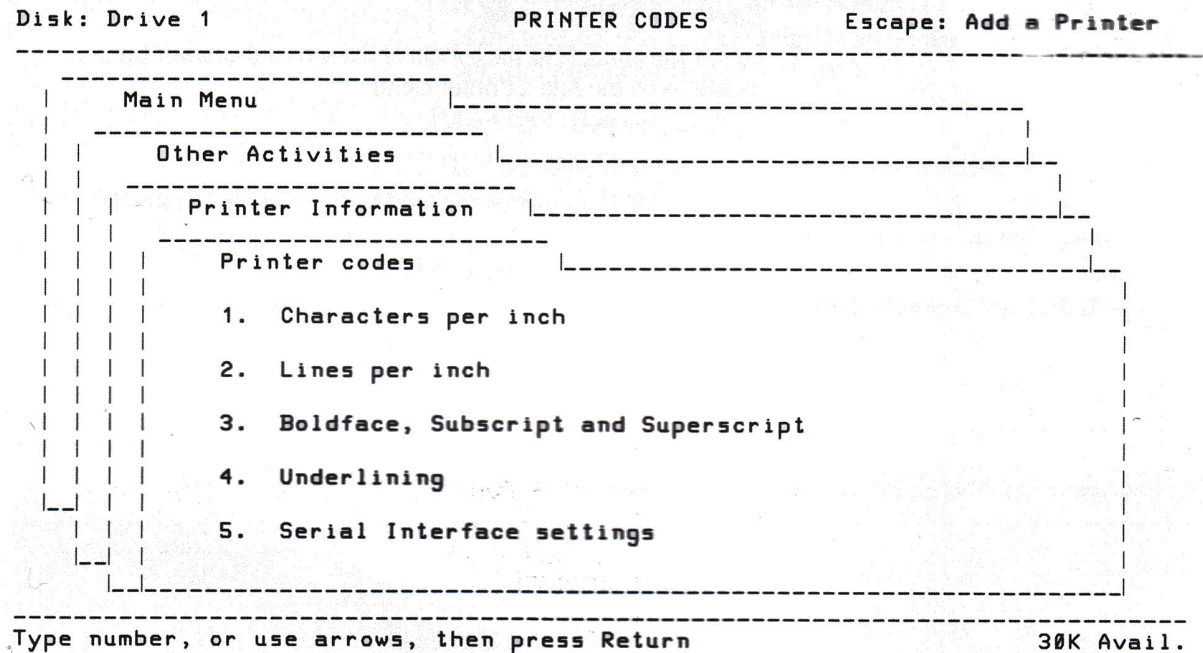

9. From the Enhancements menu, choose option 3, **Subscript Begin**.

Figure F-3. The Enhancements Menu

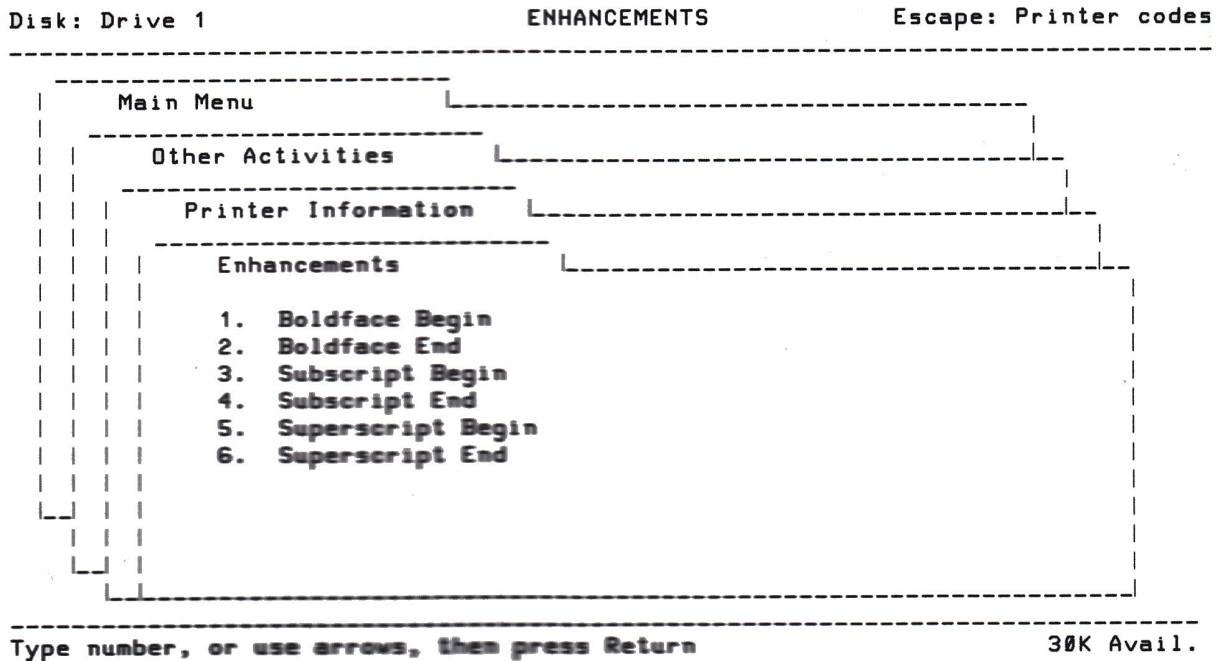

Important! | All escape characters in the next step are *lowercase*—x, y, and z.

10. Press **[ESC]** **[y]** to enter the code and **[^]** to return to the Enhancements menu.

Figure F-4. The Subscript Begin Menu

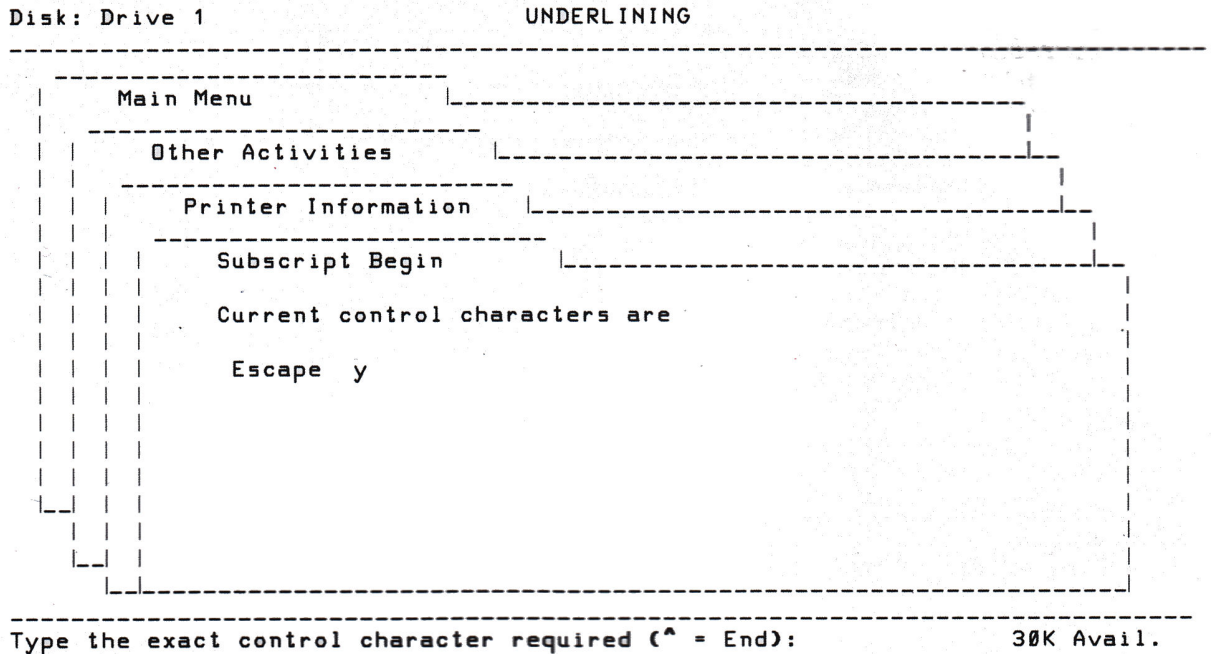

11. Choose option 4, **Subscript End**.
12. Press **[ESC]** **[z]** to enter the code and **[^]** to return to the Enhancements menu.
13. Choose option 5, **Superscript Begin**.
14. Press **[ESC]** **[x]** to enter the code and **[^]** to return to the Enhancements menu.
15. Choose option 6, **Superscript End**.
16. Press **[ESC]** **[z]** to enter the code and **[^]** to return to the Enhancements menu.

17. You should also customize for boldface and characters per inch. Follow the instructions in each menu.
 18. To return to the AppleWorks Main Menu, press **ESC** five times.
- To use your new “printer,” choose it from the menu of printers after issuing the AppleWorks Print command.

Glossary

alignment notch: The notch on the back panel that indicates where to position the left edge of a sheet of pin-feed paper.

Applesoft BASIC: An extended version of the BASIC programming language used with the Apple II family of computers.

application program: A program that applies a computer's capabilities to some particular task, such as word processing, database management, graphics, or spreadsheet work.

ASCII: An acronym for *American Standard Code for Information Interchange*, pronounced *ask' ee*. A code for representing text characters and other data inside a computer and between a computer and any peripheral device.

back cover: The cover at the rear of the ImageWriter II that protects the forms tractor.

baud: A unit of data transmission speed: the number of signal events per second. Sometimes but not always equivalent to *bits per second*.

bit: A contraction of *binary digit*. The smallest unit of data. A bit is either a zero or a one, an off or an on. The ImageWriter II takes a data byte composed of 8 bits.

buffer: An area of the computer's memory used as a *holding area* where information can be stored by one program or device and then read out by another at a different speed.

byte: A unit of information, often amounting to a single text character. A byte consists of eight bits.

card: See **peripheral card**.

carriage return: An ASCII character (decimal 13) that ordinarily causes a printer or display device to print the character following it at the left margin.

carrier rod: The metal rod on which the print head assembly rides.

cartridge support tabs: The two plastic tabs that secure the ribbon cartridge to the ribbon cartridge deck.

character pitch: The number of characters per inch printed on a horizontal line.

character set: The entire set of characters that a printer can print.

circuit board: A collection of integrated circuits (chips) wired together on a board.

command code: One or more characters that change a printer's actions.

communications protocol: A format or set of rules for sending and receiving data.

computer paper: See **pin-feed paper**.

configuration: The hardware and software elements that constitute a computer system.

configuring: The act of changing software or hardware actions by changing settings. For example, you give software the necessary settings for communicating with a printer. You can *configure* hardware (a printer or interface card) by resetting physical elements like DIP switches or jumper blocks. Configurations can also be set or reset in software.

continuous-form paper: See **pin-feed paper**.

control character: A single character produced by holding down the CONTROL key *while* pressing an alphabetic or numeric key. Some control characters act as commands to the printer. Compare **escape sequence**.

control panel: On the ImageWriter II, the cluster of buttons and lights near the lower-right corner of the printer. On the Macintosh, the software accessory through which you can set things like button click speed and speaker sound.

data byte: The basic unit of data the computer sends to the printer.

data byte length: The number of bits in a data byte. The ImageWriter II receives data in 8-bit data bytes.

Data Terminal Ready: One of the handshake lines in a data transmission interface. Also, a name for the default communications protocol for the ImageWriter II. Also known as *DTR* or *hardware handshake*. See **hardware handshake**.

default: A value, action, or setting that a computer system assumes, unless the user gives an explicit instruction to the contrary. For example, unless told otherwise, the ImageWriter II begins printing with a left margin set to the default value of zero.

DIP switch: *DIP* is an acronym for *dual in-line package*. A small block containing a number of switches. Setting these switches sets options on the device of which the switch is a part, like a printer or an interface card.

dot matrix printer: A printer, like the ImageWriter II, that forms characters with patterns of dots.

8-pin, mini-circular connector: The small, round connector on the serial interface cable that plugs into the printer. Also known as an *8-pin mini-DIN connector*.

eject: Moving paper out of the printer. You can eject paper by pressing the Form Feed button or by turning the platen knob clockwise.

end-of-line character: Any character that tells the printer that the preceding text constitutes a full line and may now be printed.

Error light: The red light that indicates a problem with the printer, such as being out of paper.

escape sequence: A sequence of keystrokes or characters beginning with `ESC`, or the ASCII code for Escape. Such sequences issue commands to the printer that position the cursor and otherwise control text formatting in a printout.

expansion slot: A connector inside the Apple II, II Plus, and IIe computers in which a peripheral card can be installed. Sometimes called a **peripheral slot**.

fan-fold paper: See **pin-feed paper**.

font: A complete set of type in one size and style of character.

format: The general shape and appearance of a printer's output, including page size, character width and spacing, line spacing, and other design matters.

form feed: An ASCII character (decimal 12) that causes a printer or other paper-handling device to advance to the top of the next page.

forms tractor: The mechanism that advances pin-feed paper through the printer.

front cover: The lid that covers the front of the ImageWriter II. Remove the front cover to gain access to the ribbon cartridge and DIP switches. The front cover must be firmly in place or the ImageWriter II will not print.

front cover window: The clear plastic piece in the upper portion of the front cover.

graphics: Displayed or printed pictures or images, as opposed to text.

hardware handshake: A protocol that tells the computer to start or stop sending data by setting the DTR (Data Terminal Ready) line logic state. The ImageWriter II changes the line's state depending on the capacity of its input buffer. Also known as the *Data Transfer Ready* protocol. Compare **XON/XOFF**.

hexadecimal: The representation of numbers in terms of powers of sixteen, using the ten digits 0 through 9 and the six letters A through F. Often used instead of decimal numbers in programming and commonly referred to as *hex*. Programmers precede hex numbers with a dollar sign (\$), for example, \$14 or \$C9.

high ASCII characters: ASCII characters with decimal values ranging from 128 through 255. Called *high* because the first, or high, bit of each character is set to 1 (for *on*) rather to 0 (for *off*).

icon: A symbol that instructs the user or labels a component of a computer, printer, cable, or cord.

ImageWriter II AppleTalk

Option: An interface card that enables the printer to serve as many as 31 computers on an AppleTalk network.

ImageWriter II SheetFeeder: A device that holds up to 100 sheets of paper, feeds them individually into the printer, and stacks the printed pages.

ImageWriter II 32K Memory

Option: An interface card that gives the ImageWriter II a 32,768-character memory buffer. This memory holds documents of up to 16 to 20 pages, freeing the computer for other work during printing.

Integer BASIC: A version of the BASIC language that processes numbers in integer (fixed-point) form rather than in decimal (floating-point) form. Available for the Apple II family of computers.

interface: Hardware or software that links the computer to a device, such as a printer or modem.

interface card: See **peripheral card**.

K: Short for *kilobyte*. The amount of computer or disk memory. One K equals 1024 bytes.

line feed: The ASCII character that causes the printer to move the paper forward by one line.

line feed pitch: The number of lines of text printed per vertical inch.

machine language: Instructions in a form that a microprocessor can directly execute. Each processor has its own form of machine language.

microprocessor: A small, integrated circuit component that performs a complete set of computing functions. The computer's brain.

modem: Acronym for *MOdulator/DEModulator*; a peripheral device through which a computer can send and receive data over telephone lines.

network: A group of individually controlled computers linked together with peripherals. Through hardware and software, the computers can share information and other resources. AppleTalk is an office network.

On/Off button: A button on the control panel of the ImageWriter II that you press to turn the printer on or off.

output: Data transferred from a computer to an external device, such as a video display, printer, disk drive, or modem.

override: To modify or cancel one instruction with another. For example, you might override a DIP switch setting with an escape sequence.

paper bail: The small shaft that runs across the top of the platen. Its two rollers and plastic bar hold the paper next to the platen.

paper clamps: The clamps that keep pin-feed paper from popping off the form-feed tractors.

paper guide: The clear plastic plate that rides between the print head and the platen.

paper load: A function performed on single sheets of paper by the Form Feed button. The paper load function loads a sheet of paper and set its top of form to 1/6 inch from the top edge of the paper.

paper release lever: The lever next to the platen knob. The lever's position determines how the printer moves paper. Move the lever up for pin feed and down for friction feed.

paper thickness lever: The lever at the right end of the platen that sets the friction-feed mechanism for 1 to 4 sheets of paper. The up position is for a single sheet of 16- to 24-pound bond.

parallel interface: An interface that transmits multiple bits simultaneously (usually in one-byte lengths). Compare **serial interface**.

parity: A redundant bit added to a data byte to check for transmission errors. The ImageWriter II does not read a parity bit.

peripheral card: A removable printed circuit board that plugs into one of the expansion slots in the Apple II, II Plus, and IIe. Such cards can either transfer computer data to a peripheral devices, such as a printer or modem, or expand the computer's own capabilities by adding extra memory or an extra microprocessor.

pin-feed alignment icon: The icon on the back panel of the printer that shows you where to position the left edge of a sheet of pin-feed paper.

pin-feed paper: Paper designed for computer printers. Each vertical edge has regularly spaced holes (pin holes) that the printer uses to advance the paper. Perforations separate each sheet and the individual sheets can be folded like the letter Z for stacking. Also known as *fan-fold paper*, *continuous-form paper*, or *computer paper*.

platen: The rubber roller that serves as a backing for the paper during printing and paper loading.

platen knob: The knob at the right side of the printer. Turning the knob clockwise advances paper into the printer.

port: The point of connection between a computer and a peripheral device, another computer, or a network.

power cord: The cord that connects the printer to its source of electricity.

Power light: The green light that tells you when the printer is turned on.

power socket: The socket at the back of the printer into which you plug the power cord.

PR#: In the Apple II family of computers, the PR# command sends output to a slot. For example, PR#1 sends output to the device located in slot 1. PR#0 returns output to the video display.

print head: The printer part that actually prints characters.

print line: The red line on the paper guide that indicates where the printer prints on the paper.

printout: Text and graphics printed on paper by a printer.

protocol: See **communications protocol**.

RAM: See **random-access memory**.

random access memory (RAM): Memory that retains data only so long as power to the memory remains on. Also known as *working memory*. When you load a program and data into the computer, you load them into RAM. Likewise, what you type at the keyboard goes into RAM. The ImageWriter II has 2K of RAM which receives and holds data from the computer. You can “write” information into RAM and “read” it back. Compare **read-only memory**.

ribbon adjustment assembly: This assembly gives you a way to adjust the angle of a color ribbon when color overlap problems appear. The assembly is located on the **ribbon cartridge deck**.

ribbon cartridge deck: The platform that holds the ribbon cartridge.

ribbon guide: The rectangle of plastic that rises over the print head. The ribbon travels *between* the ribbon guide and the paper guide.

ROM: See **read-only memory**.

read-only memory (ROM): A memory chip, the contents of which can only be read. ROM cannot be written to or otherwise modified; used for storing firmware. ROM carries data built into it when manufactured. ROM's normally store the basic startup and operating information for computers and peripherals. Languages, like Applesoft BASIC, are also put into ROM.

RS232: A common data communications interface standard. The ImageWriter II follows this standard.

Select button: The button that determines whether the printer can accept data from the computer or instructions from other buttons on the control panel.

Select light: When the Select light is on, the printer can receive data from a computer. With the exception of the On/Off button, none of the control panel buttons works when the Select light is on. When the Select light is off, all buttons work, but the printer cannot print.

serial interface: An interface that transmits data sequentially, one bit at a time. Compare **parallel interface**.

serial interface cable: The cable that connects the serial ports of two devices, such as those of a computer and a printer. See **serial interface**.

serial interface socket: The ImageWriter II socket that accepts the serial interface cable's 8-pin, mini-circular connector.

setup string: A group of characters that sends a format command to a printer. Some application programs, such as spreadsheets, give you the option of changing format, such as character width, by entering a setup string before printing.

shielded cable: A cable with a special metallic wrapping around its wires. This wrapping reduces radio frequency interference.

slot: See **expansion slot**.

software: Instructions that tell the computer what to do: computer programs. Software includes applications like word processing programs and programs that control the activities of the computer and its peripherals.

spreadsheet: An application program used for financial planning, cost estimates, and other number-crunching tasks. In a spreadsheet, information is laid out in columns and rows.

start bit: In serial data transmission, the one bit preceding a data byte that indicates the beginning of a character.

stop bit: In serial data transmission, the one or two bits preceding a data byte that indicate the end of a character.

TAB: An ASCII character that commands a device, such as a printer, to begin printing at a preset location. Similar to a typewriter tab.

text: Information presented in the form of alphabetic, numeric, and punctuation characters. Compare **graphics**.

top margin: The distance from the top edge of a page to the first printed line of text.

top of form: An imaginary line on a page where the printer will print the page's first line.

tractor: A belt with pins that guides pin-feed paper into the printer. The ImageWriter II has two tractors, one for each column of pin holes.

tractor release lever: In the down position, the lever locks its tractor into position. The up position frees the tractor for adjustment to a different paper width.

wires: The nine elements in the print head that strike the ribbon and create a dot pattern on the paper. The dot pattern can be a text character or part of a graphic image.

XON/XOFF: A communications protocol that tells the computer to start or stop sending data by sending the appropriate character: either an XON or XOFF. The ImageWriter II sends an XOFF when its input buffer is nearly full and an XON when it has room for more data. Compare **hardware handshake**.

Index

A

- accessories 5-6, 51-52
- address labels, printing 49
- adjusting for paper thickness 48-49
- adjusting the color ribbon 60
- aligning pin-feed paper 17
- American language font 75, 86
- AppleCare Service Agreement 66
- Applesoft BASIC, controlling printer with 77
- AppleTalk Option 6, 52
- Apple III
 - configuring 98-99
 - connecting to 98
- Apple II
 - connecting to 32-37
 - serial interface cable for 26
 - Super Serial Card and 32-36
 - testing 37
- Apple IIc
 - connecting to 31-32
 - serial interface cable for 26
 - testing 31-32
- Apple IIe
 - connecting to 32-37
 - serial interface cable for 26
 - testing 37
- Apple II Plus
 - connecting to 32-37
 - serial interface cable for 26
 - Super Serial Card and 32-36
 - testing 37
- AppleWorks, using half-height sub/superscripts 107-111
- ASCII codes 72, 80-81

B

- BASIC**, controlling printer with 77
- baud rate(s)**
 - DIP switches and 87
 - mismatched 57
- boldface**, selecting 74
- British language font** 75, 86

C

- cable**, printer 26-27, 93-94
- cardboard retainer** 9
- carriage return**, DIP switches and 86
- case**, importance of 73
- changing**
 - DIP switch settings 70-71
 - output 72-77
 - ribbons 3
- characters**
 - half-height, selecting 74
 - per inch, DIP switches and 86
 - problems with output of 56-59
- character sets** 4
- character size**, selecting 74
- cleaning** 64-65
- color(s)**
 - default 47
 - selecting 76
- color printing** 4, 47
- testing** 23
- color ribbons** 4, 10
 - adjusting 60
- communications protocols**, problems with 58-59
- computer paper**
 - See* pin-feed paper
- configuring**
 - Apple III 98-99
 - AppleWorks for half-height sub/superscripts 107-111
 - non-Apple serial cards 102-103
 - Serial Communications Card 102-103
 - Serial Interface Card 102-103
 - software 56
 - Super Serial Card 32-33
- connecting**
 - power 12-13
 - printer cable 93-94
 - Super Serial Card 34-35
 - to Apple III 98
 - to Apple II 32
 - to Apple IIc 31-32
 - to Apple IIe 32
 - to Apple II Plus 32
 - to Lisa Office System 97-98
 - to Macintosh Plus and Macintosh 29-31
 - to Macintosh XL 94-96
- continuous-form paper**
 - See* pin-feed paper
- control characters** 72-77
- controlling**
 - output 68-77
 - printer, with Applesoft BASIC 77
- control panel** 41

D

Danish language font 75, 86
data transmission rates 57
default color 47
DIP switch(es)
 baud rate and 87
 carriage return and 86
 changing settings of 70-71
 characters per inch and 86
 default settings of 71
 form length and 86
 hardware handshake protocol
 and 87
 language fonts and 86
 line feed and 86
 location of 70
 mismatched settings and 56
 option card and 87
 perforation skip and 86
 protocols and 87
 software and 68
 Super Serial Card settings 33
 SW1-8 60
 SW2-1 59
 SW2-2 59
 SW2-3 59
 SW2-4 42, 52, 56
 SW2-5 70-71
 SW2-6 70-71
 XON/XOFF protocol and 87
discharging static electricity 32
disks
 updating Macintosh 31
 updating Macintosh XL 96
Draft Quality printing 3, 42

E

8-pin mini-circular connector 28, 88
Eject button
 See Form Feed button
ejecting paper 45-47
envelopes, printing 50-51
environment for printer 40, 64
Error light 13, 41-42, 56
escape sequences 72-77

F

fan-fold paper
 See pin-feed paper
fonts, language 75, 86
formatting text 4
form feed 44-47
Form Feed button 21-22, 44, 61
form length, DIP switches and 86
forms (multipart), printing 49-50
forms tractor 14, 15
 setting 49
French language font 75, 86
front cover 12
front cover window 12

G

German language font 75, 86
grounding plug 13

H

half-height characters
 selecting 74
 sub/superscripts, configuring
 AppleWorks for 107-111

hardware handshake protocol, DIP
 switches and 87
humidity 40, 64

I, J, K

installing
 ribbon cartridge 10-12
 Serial Interface Card 34-36
interference xi-xii, 28 94
Italian language font 75, 86

L

labels, address 49
language fonts 86
 selecting 75
left margin 76
line feed, DIP switches and 86
Line Feed button 43
line-feed character 60
lines per inch, selecting 74
Lisa Office System
 connecting to 97-98
 testing 98
loading
 paper 3, 14-22, 40
 pin-feed paper 14-20
 single sheets 20-22
lowercase characters 73

M

Macintosh Plus and Macintosh
 connecting to 29-31
 print quality and 43
 printer software problems 30-31
 serial interface cable for 27
 testing 30
32K Memory Option and 52

Macintosh XL
connecting to 94-96
printer software problems 30-31
testing 95-96
margins, setting 19, 46, 76
Memory Option, 32K 6, 51-52
Modem-8 Cable 92
multipart forms, printing 49-50

N

Near Letter Quality printing 3, 42

O

On/Off button 13, 41
operating environment 40, 64
option card, DIP switches and 87
output
changing 72-77
controlling 68-77
problems with 56-61

P, Q

paper
ejecting 45-47
Form Feed button and 21-22, 44
loading 3, 14-22, 40
margins and 19, 46
pin-feed 15-20, 44-47
single sheets 20-21, 44
storing 40
thickness, adjusting for 48-49
weight 20
Paper Load button
See Form Feed button

paper thickness lever 48
perforation skip, DIP switches and 86
pin-feed alignment icon 17
pin-feed paper
aligning 17-18
loading 15-20
single sheets and 44
top of form and 44-45
plastic retainer tube 9
power 10
connecting 12-13
testing for 54
Power light 13, 41
printer cable 26-27, 92
connecting 28-32, 93-98
printing
address labels 49
color 4, 23, 47, 60
Draft Quality 3, 42
envelopes 50-51
multipart forms 49-50
Near Letter Quality 3, 42
Standard Quality 3, 42
print quality 3, 42-43
Macintosh and 43
problems with 59-60
selecting through software 74
selection lights 43
Print Quality button 43
print speed 3, 42
proportional spacing, selecting 74
protocols
DIP switches and 87
problems with 58-59

R

radio interference xi-xii, 28, 94
removing ribbon cartridge 12
resetting top of form 45
ribbon(s)
black 10
changing 3
color 4, 10
ribbon adjustment ring 60
ribbon cartridge
installing 10-12
parts of 11
removing 12

S

selecting
colors 76
language fonts 75
special features 74
Select button 21, 42
Select light 21, 42
self-test 23
serial cards, configuring non-Apple
102-103
Serial Communications Card,
configuring 102-103
See also Serial Interface Card
serial interface cable 26-27
Serial Interface Card
configuring 102-103
installing 34-36
service 65
setting
forms tractor 49
margins 19, 46, 76

settings

- changing DIP switch 70-71
- changing with software 72-77
 - standard 69
- setup string 68
- SheetFeeder 5, 51
- single-sheet icon 21
- single sheets
 - loading 20-22
 - pin-feed paper and 44
 - problems feeding 59
- slashed zeros, selecting 74
- software
 - changing settings with 72-77
 - configuring 56
 - DIP switches and 68
- spacing
 - problems with 58-59
 - proportional, selecting 74
- Spanish language font 75, 86
- special features, selecting 74
- specifications 84-89
- Standard Quality printing 3, 44
- standard settings 69
- starting 12-14
- static electricity, discharging 32
- storing
 - paper 40
 - printer 64

subscripts

- configuring AppleWorks for
 - half-height 106-111
- selecting 74
- superscripts
 - configuring AppleWorks for
 - half-height 106-111
 - selecting 74
- Super Serial Card
 - Apple II and 35
 - Apple II Plus and 35
 - configuring 32-33
 - DIP switch settings 33
 - See also* Serial Interface Card
- support 66
- surge protection 10
- Swedish language font 75, 86

T

- television interference xi-xii, 28, 94
- temperature 40, 64
- testing
 - Apple II connection 37
 - Apple IIc connection 31-32
 - Apple IIe connection 37
 - Apple II Plus connection 37
 - color printing 23
 - Lisa Office System connection 98
 - Macintosh Plus and Macintosh connection 30
 - Macintosh XL connection 95-96
 - power 54
 - self-test 23

text formatting 4

- thickness, paper 48-49
- 32K Memory Option 6, 51-52
- top margin 19, 46
- top of form 44-45, 76
- tractors
 - See* forms tractor
- troubleshooting 54-61

U, V, W

- underlining, selecting 74
- unpacking 8-10
- updating
 - Macintosh disks 31
 - Macintosh XL disks 96
- uppercase characters 73

X, Y

- XON/XOFF protocol, DIP switches and 87

Z

- zeros (slashed), selecting 74



ImageWriter II

Quick Reference Card

Control Codes and Escape Sequences

Function	Keystrokes	Code	Comment
Type Size			
Extended	ESCAPE n	27 110	9 characters per inch
Pica	ESCAPE N	27 78	10 characters per inch
Elite	ESCAPE E	27 69	12 characters per inch
Pica proportional	ESCAPE p	27 112	
Elite proportional	ESCAPE P	27 80	
Semicondensed	ESCAPE e	27 101	13.4 characters per inch
Condensed	ESCAPE q	27 113	15 characters per inch
Ultracondensed	ESCAPE Q	27 81	17 characters per inch
Set n dots	ESCAPE _n	27 d	Between proportional characters (n = 1 to 6)
Set spacing to n dots	ESCAPE s_n	27 115 d	Between proportional characters (n = 0 to 9)
Print Formatting			
Underline begin	ESCAPE X	27 88	
Underline end	ESCAPE Y	27 89	
Boldface begin	ESCAPE !	27 33	
Boldface end	ESCAPE "	27 34	
Headline begin	CONTROL-N	14	
Headline end	CONTROL-O	15	
Superscript begin	ESCAPE x	27 120	
Superscript end	ESCAPE z	27 122	
Subscript begin	ESCAPE y	27 121	
Subscript end	ESCAPE z	27 122	
Half-high begin	ESCAPE w	27 119	
Half-high end	ESCAPE W	27 87	
Slashed zero begin	ESCAPE D	27 68 0 1	
	CONTROL-@ CONTROL-A		
Slashed zero end	ESCAPE Z	27 90 0 1	
	CONTROL-@ CONTROL-A		
Repeat character	ESCAPE R nnn c	27 82 ddd d	Print character c nnn times



ImageWriter II

Quick Reference Card

Control Codes and Escape Sequences

Function	Keystrokes	Code	Comment
Type Size			
Extended	ESCAPE n	27 110	9 characters per inch
Pica	ESCAPE N	27 78	10 characters per inch
Elite	ESCAPE E	27 69	12 characters per inch
Pica proportional	ESCAPE p	27 112	
Elite proportional	ESCAPE P	27 80	
Semicondensed	ESCAPE e	27 101	13.4 characters per inch
Condensed	ESCAPE q	27 113	15 characters per inch
Ultracondensed	ESCAPE Q	27 81	17 characters per inch
Set n dots	ESCAPE _n	27 d	Between proportional characters (n = 1 to 6)
Set spacing to n dots	ESCAPE s_n	27 115 d	Between proportional characters (n = 0 to 9)
Print Formatting			
Underline begin	ESCAPE X	27 88	
Underline end	ESCAPE Y	27 89	
Boldface begin	ESCAPE !	27 33	
Boldface end	ESCAPE "	27 34	
Headline begin	CONTROL-N	14	
Headline end	CONTROL-O	15	
Superscript begin	ESCAPE x	27 120	
Superscript end	ESCAPE z	27 122	
Subscript begin	ESCAPE y	27 121	
Subscript end	ESCAPE z	27 122	
Half-high begin	ESCAPE w	27 119	
Half-high end	ESCAPE W	27 87	
Slashed zero begin	ESCAPE D	27 68 0 1	
	CONTROL-@ CONTROL-A		
Slashed zero end	ESCAPE Z	27 90 0 1	
	CONTROL-@ CONTROL-A		
Repeat character	ESCAPE R nnn c	27 82 ddd d	Print character c nnn times

Function	Keystrokes	Code	Comment
Character Sets			
96 ASCII characters	ESCAPE \$	27 36	
MouseText characters	ESCAPE &	27 38	
International Language Fonts			
American	ESCAPE Z CONTROL-G CONTROL-@	27 90 7 0	
British	ESCAPE Z CONTROL-D CONTROL-@ ESCAPE D CONTROL-C CONTROL-@	27 90 4 0 27 68 3 0	
German	ESCAPE Z CONTROL-C CONTROL-@ ESCAPE D CONTROL-D CONTROL-@	27 90 3 0 27 68 4 0	
French	ESCAPE Z CONTROL-A CONTROL-@ ESCAPE D CONTROL-F CONTROL-@	27 90 1 0 27 68 6 0	
Swedish	ESCAPE Z CONTROL-B CONTROL-@ ESCAPE D CONTROL-E CONTROL-@	27 90 2 0 27 68 5 0	
Italian	ESCAPE Z CONTROL-F CONTROL-@ ESCAPE D CONTROL-A CONTROL-@	27 90 6 0 27 68 1 0	
Spanish	ESCAPE D CONTROL-G CONTROL-@	27 68 7 0	
Danish	ESCAPE Z CONTROL-E CONTROL-@ ESCAPE D CONTROL-B CONTROL-@	27 90 5 0 27 68 2 0	
Fonts			
Draft	ESCAPE a 1	27 97 49	
Standard	ESCAPE a 0	27 97 48	
Near Letter Quality	ESCAPE a 2	27 97 50	
Colors			
Black	ESCAPE K 0	27 75 48	
Yellow	ESCAPE K 1	27 75 49	
Red	ESCAPE K 2	27 75 50	
Blue	ESCAPE K 3	27 75 51	
Orange	ESCAPE K 4	27 75 52	
Green	ESCAPE K 5	27 75 53	
Purple	ESCAPE K 6	27 75 54	

Function	Keystrokes	Code	Comment
Printer Direction			
Left to right only	ESCAPE >	27 62	
Bidirectional	ESCAPE <	27 60	
Backspace and print	CONTROL-H c	8 d	Backspace and print character c
Positioning			
Feed to top of form	CONTROL-L	12	
Set top of form	ESCAPE v	27 118	
Set left margin	ESCAPE L nnn	27 76 ddd	nnn = character position
Lines per Inch			
6 lines per inch	ESCAPE A	27 65	
8 lines per inch	ESCAPE B	27 66	
Distance between lines	ESCAPE T nn	27 84 dd	nn/144 (nn = 01 to 99)
Set form length	ESCAPE H nnnn	27 72 dddd	In increments of nnnn/144
End of Line			
End of line at carriage return only	ESCAPE Z @ CONTROL-@	27 90 64 0	
End of line at carriage return or form feed	ESCAPE D @ CONTROL-@	27 68 64 0	
Line Feeds			
No carriage return before line feed	ESCAPE l 1	27 108 49	
Add carriage return before line feed	ESCAPE l 0	27 108 48	
Forward line feed	ESCAPE f	27 102	
Reverse line feed	ESCAPE r	27 114	
Feed n lines	CONTROL- n	31 d	n = 1, 2, 3, 4, 5, 6, 7, 8, 9
Buffer Controls			
Cancel unprinted text	CONTROL-X	24	
No line feed at buffer	ESCAPE Z _ CONTROL-@	27 90 32 0	Overflow (_ = space character)
Line feed added at buffer	ESCAPE D _ CONTROL-@	27 68 32 0	Overflow (_ = space character)
Tabbing Controls			
Set horizontal tabs	ESCAPE (a, b, n, ... , .	27 40, n, n, n, ... , 46	abn = column number through nth column
Set one additional tab	ESCAPE u n	27 117 n	
Clear selected tabs	ESCAPE) a, b, n, ... , .	27 41, n, n, n, ... , 46	abn = column number through nth column
Clear all horizontal tabs	ESCAPE 0	27 48	

Function	Keystrokes	Code	Comment
Down-Loading Characters			
Select down-load characters	ESCAPE '	27 39	Normal ASCII down-loaded characters
Select down-load characters	ESCAPE *	27 42	High ASCII down-loaded characters
Select ROM character set	ESCAPE \$	27 36	
16-column maximum width characters	ESCAPE +	27 43	
8-column maximum width characters	ESCAPE -	27 45	
Begin down load	ESCAPE I	27 73	
End down load	CONTROL-D	4	
Bit Image Graphics			
Print next nnnn bytes as bit image graphics	ESCAPE G nnnn	27 71 dddd	nnnn = number of bytes
Print next nnn × 8 bytes as bit image graphics	ESCAPE g nnn	27 103 ddd	
Repeat dot pattern nnnn times	ESCAPE V nnnn	27 86 dddd	1 byte pattern
Begin printing at dot position nnnn	ESCAPE F nnnn	27 70 dddd	
Miscellaneous			
Ignore 8th bit	ESCAPE D CONTROL-@_	27 68 0 32	Default (_ = space character)
Recognize 8th bit	ESCAPE Z CONTROL-@_	27 90 0 32	(_ = space character)
Paper error detector off	ESCAPE O	27 79	
Paper error detector on	ESCAPE o	27 111	Default
Software reset power on defaults	ESCAPE c	27 99	Restore power on defaults
Self ID	ESCAPE ?	27 63	

DIP Switch Settings

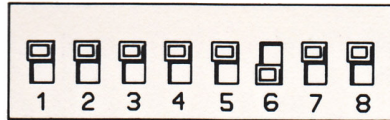

SW1

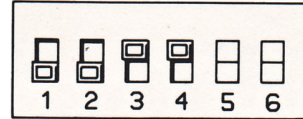

SW2

Open ↑
↓ Closed

	SW1-1	SW1-2	SW1-3
American	Open	Open	Open
Italian	Closed	Open	Open
Danish	Open	Closed	Open
British	Closed	Closed	Open
German	Open	Open	Closed
Swedish	Closed	Open	Closed
French	Open	Closed	Closed
Spanish	Closed	Closed	Closed
		SW1-4	
Form length 11 inches		Open	
Form length 12 inches		Closed	
		SW1-5	
Perforation skip inactive		Open	
Perforation skip active		Closed	
		SW1-6	SW1-7
10 characters per inch		Open	Open
12 characters per inch		Closed	Open
17 characters per inch		Open	Closed
160 dots per inch (proportional)		Closed	Closed
		SW1-8	
Carriage return only		Open	
Carriage return plus line feed		Closed	
		SW2-1	SW2-2
300 baud		Open	Open
1200		Closed	Open
2400		Open	Closed
9600		Closed	Closed
		SW2-3	
Hardware Handshake Protocol		Open	
XON/XOFF Protocol		Closed	
		SW2-4	
Option disabled (no option card)		Open	
Option enabled		Closed	

▲ Warning

Do not adjust DIP switches SW2-5 and SW2-6.
They are factory set to control hammer-fire timing.

Notes

Tell Apple About Your Printer

Your Name: _____
Your Title: _____
Company: _____
Address: _____
City/State/Zip: _____
Work Phone: _____
Home Phone: _____

Part 1: Tell Apple About You

1. How much prior experience have you had using computers?
 None Little Moderate Extensive

2. What computers have you used? _____

Part 2: Tell Apple About Your System

1. Which Apple computer are you using?
 Apple II Plus Apple IIe Apple IIc
 Apple III Macintosh Macintosh XL
 Other _____
(please specify)

2. How much memory does it have? _____ K

3. Please list the date of purchase. _____

4. Please list any devices attached to your computer—for example: Apple Joystick, Disk Drive IIc, Apple Modem.

Apple uses comments and suggestions from Apple computer owners like you to improve existing products and develop new and better products. Now that you've used this product, we want to know your suggestions and thoughts about your experience. Please use this form to tell Apple what you think.

Your Dealer Can Help: Apple can't respond to your individual questions. If you have a question, would like help, or need service, please contact your Apple dealer.

3. Where do you use your Apple computer? Check all that apply.
 Home Work School Other _____

4. How many people in your family/office use the Apple computer?
Adults _____ Children _____

7. Do you plan to write computer programs? Yes No
If yes, which computer language(s) will you use?

8. What application programs do you use or plan to use with your Apple computer?
 Word Processing Data Management
 Spreadsheet Education
 Games Communication

Graphics Other _____

9. Please list the products (program, operating system, or language) you use.

Name of Software _____ Version Number _____

5. Which printer are you using?

Imagewriter II Scribe

6. Are you using a monitor or a television set?

Monitor Television Built-in screen

What kind is it?

Monochrome (or black-and-white TV)

Color Other _____

Brand Name _____

10. Please give us any suggestions or comments and tell us about any problems you've had with your Apple computer. (Feel free to attach additional sheets.)

Part 3: Tell Apple About Your Printer

Please take a few minutes to tell Apple what you thought of the printer.

1. Did the manual give you the information you need to use the printer?

2. What did you like best/least about this manual?

3. Was the information presented appropriately for your level of computer expertise?

Too Elementary Just Right Too Complex

4. Please describe specific problems you encountered with the printer or its manual. (Page numbers would be helpful. Feel free to attach additional sheets.)

5. Overall, how would you rate this product?

Low	1	2	3	4	5	6	7	8	9	10	High

Thank you for your time and effort.



Tuck end flap inside back cover when using manual.



Apple Computer, Inc.
20525 Mariani Avenue
Cupertino, California 95014
(408) 996-1000
TLX 171-576

030-2002-D
Printed in Japan